

TOSHIBA



DVD VIDEO PLAYER & VIDEO CASSETTE RECORDER

SD-V394SU

OWNER'S MANUAL

VHS Hi-Fi SQPB

| | |
|-------------------------|----|
| Introduction | 2 |
| Connections | 14 |
| Basic setup (VCR) | 22 |
| Playback (VCR) | 29 |
| Recording (VCR) | 34 |
| Other functions (VCR) | 39 |
| Basic playback (DVD) | 42 |
| Advanced playback (DVD) | 45 |
| Function setup (DVD) | 58 |
| Others | 65 |



©2006 Toshiba Corporation
This device does not tape-record copy protected DVD Video Discs.

SAFETY PRECAUTIONS

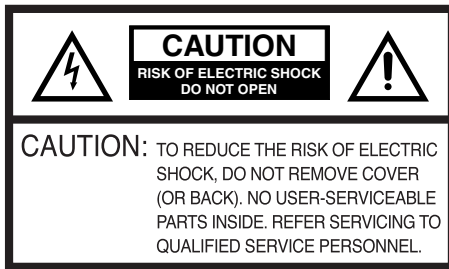

The lightning flash with arrowhead symbol, within an equilateral triangle is intended to alert the user to the presence of uninsulated dangerous voltage within the product's enclosure that may be of sufficient magnitude to constitute a risk of electric shock to persons.



The exclamation point within an equilateral triangle is intended to alert the user to the presence of important operating and maintenance (servicing) instructions in the literature accompanying the appliance.

WARNING: TO REDUCE THE RISK OF FIRE OR ELECTRIC SHOCK, do not expose this appliance to rain or moisture.

CAUTION: TO PREVENT ELECTRIC SHOCK DO NOT USE THIS POLARIZED PLUG WITH AN EXTENSION CORD, RECEPTACLE OR OTHER OUTLET UNLESS THE BLADES CAN BE FULLY INSERTED TO PREVENT BLADE EXPOSURE.

FCC NOTICE: This equipment has been tested and found to comply with the limits for a Class B digital device, pursuant to Part 15 of the FCC Rules. These limits are designed to provide reasonable protection against harmful interference in a residential installation. This equipment generates, uses and can radiate radio frequency energy and, if not installed and used in accordance with the instructions, may cause harmful interference to radio communications.

However, there is no guarantee that interference will not occur in a particular installation. If this equipment does cause harmful interference to radio or television reception, which can be determined by turning the equipment off and on, the user is encouraged to try to correct the interference by one or more of the following measures:

- Reorient or relocate the receiving antenna.
- Increase the separation between the equipment and receiver.
- Connect the equipment into an outlet on a circuit different from that to which the receiver is connected.
- Consult the dealer or an experienced radio/TV technician for help.

CAUTION: Changes or modifications not expressly approved by the party responsible for compliance with the FCC Rules could void the user's authority to operate this equipment.

CAUTION: THIS DIGITAL VIDEO PLAYER EMPLOYS A LASER SYSTEM.

TO ENSURE PROPER USE OF THIS PRODUCT, PLEASE READ THIS USER'S GUIDE CAREFULLY AND RETAIN FOR FUTURE REFERENCE. SHOULD THE UNIT REQUIRE MAINTENANCE, CONTACT AN AUTHORIZED SERVICE LOCATION.

USE OF CONTROLS, ADJUSTMENTS OR THE PERFORMANCE OF PROCEDURES OTHER THAN THOSE SPECIFIED HEREIN MAY RESULT IN HAZARDOUS RADIATION EXPOSURE.

TO PREVENT DIRECT EXPOSURE TO LASER BEAM, DO NOT TRY TO OPEN THE ENCLOSURE. VISIBLE LASER RADIATION MAY BE PRESENT WHEN THE ENCLOSURE IS OPENED. DO NOT STARE INTO BEAM.

Location of the required Marking

The rating sheet and the safety caution are on the rear of the unit.

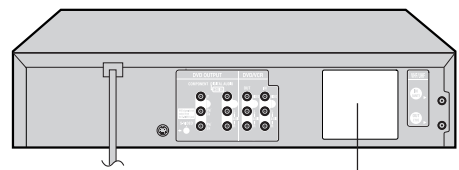

CERTIFICATION: COMPLIES WITH FDA RADIATION PERFORMANCE STANDARDS, 21 CFR SUBCHAPTER J.



IMPORTANT SAFEGUARDS

1. READ INSTRUCTIONS

All the safety and operating instructions should be read before the unit is operated.

2. RETAIN INSTRUCTIONS

The safety and operating instructions should be retained for future reference.

3. HEED WARNINGS

All warnings on the unit and in the operating instructions should be adhered to.

4. FOLLOW INSTRUCTIONS

All operating and use instructions should be followed.

5. CLEANING

Unplug this unit from the wall outlet before cleaning. Do not use liquid cleaners or aerosol cleaners.

Use a soft dry cloth for cleaning the exterior cabinet only.

6. ATTACHMENTS

The manufacturer of this unit does not make any recommendations for attachments, as they may cause hazards.

7. WATER AND MOISTURE

Do not use this unit near water. For example, near a bathtub, washbowl, kitchen sink, laundry tub, in a wet basement, or near a swimming pool.

8. ACCESSORIES

Do not place this unit on an unstable cart, stand, tripod, bracket, or table.

The unit may fall, causing serious injury, and serious damage to the unit.

- 8A. An appliance and cart combination should be moved with care. Quick stops, excessive force, and uneven surfaces may cause the appliance and cart combination to overturn.

9. VENTILATION

Slots and openings in the cabinet back or bottom are provided for ventilation, to ensure reliable operation of the unit, and to protect it from overheating.

These openings must not be blocked or covered. The openings should never be blocked by placing the unit on a bed, sofa, rug, or other similar surface. This unit should never be placed near or over a radiator or heat source. This unit should not be placed in a built-in installation such as a bookcase or rack unless proper ventilation is provided and/or the manufacturer's instructions have been adhered to.

10. POWER SOURCE

This unit should be operated only from the type of power source indicated on the rating plate. If you are not sure of the type of power supply to your home, consult your appliance dealer or local power company.

11. GROUNDING OR POLARIZATION

This unit is equipped with a polarized alternating-current line plug (a plug having one blade wider than the other). This plug will fit into the power outlet only one way. This is a safety feature. If you are unable to insert the plug fully into the outlet, try reversing the plug. If the plug should still fail to fit, contact your electrician to replace your obsolete outlet. Do not defeat the safety purpose of the grounding-type plug.

12. POWER-CORD PROTECTION

Power-supply cords should be routed so that they are not likely to be walked on or pinched by items placed upon or against them, paying particular attention to cords at plugs, convenience receptacles, and the point where they exit from the appliance.

PORTABLE CART WARNING
(symbol provided by RETAC)



S3125A

IMPORTANT SAFEGUARDS

13. LIGHTNING

To protect your unit from a lightning storm, or when it is left unattended and unused for long periods of time, unplug it from the wall outlet and disconnect the antenna or cable system. This will prevent damage to the unit due to lightning and power line surges.

14. POWER LINES

An outside antenna system should not be located in the vicinity of overhead power lines or other electric light or power circuits, or where it can fall onto or against such power lines or circuits. When installing an outside antenna system, extreme care should be taken to keep from touching such power lines or circuits, as contact with them might be fatal.

15. OVERLOADING

Do not overload wall outlets and extension cords, as this can result in a risk of fire or electric shock.

16. OBJECT AND LIQUID ENTRY

Do not push objects through any openings in this unit, as they may touch dangerous voltage points or short out parts that could result in fire or electric shock. Never spill or spray any type of liquid into the unit.

17. OUTDOOR ANTENNA GROUNDING

If an outside antenna or cable system is connected to the unit, be sure the antenna or cable system is grounded to provide some protection against voltage surges and built-up static charges, Section 810 of the National Electrical Code, ANSI/NFPA 70, provides information with respect to proper grounding of the mast and supporting structure, grounding of the lead-in wire to an antenna discharge unit, size of grounding conductors, location of antenna discharge unit, connection to grounding electrodes, and requirements for the grounding electrode.

EXAMPLE OF ANTENNA GROUNDING AS PER THE NATIONAL ELECTRICAL CODE

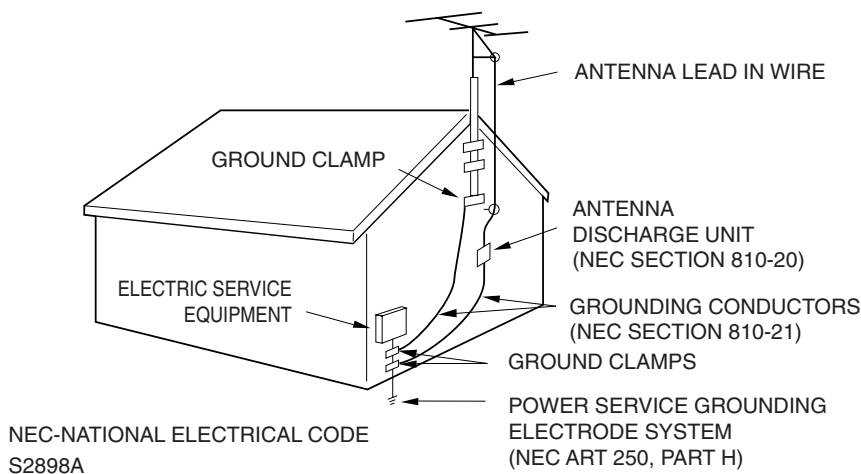

18. SERVICING

Do not attempt to service this unit yourself as opening or removing covers may expose you to dangerous voltage or other hazards. Refer all servicing to qualified service personnel.

For example:

- a. When the power-supply cord or plug is damaged.
- b. If liquid has been spilled, or objects have fallen into the unit.
- c. If the unit has been exposed to rain or water.
- d. If the unit does not operate normally by following the operating instructions. Adjust only those controls that are covered by the operating instructions, as an improper adjustment of other controls may result in damage and will often require extensive work by a qualified technician to restore the unit to its normal operation.
- e. If the unit has been dropped or the cabinet has been damaged.
- f. When the unit exhibits a distinct change in performance, this indicates a need for service.

IMPORTANT SAFEGUARDS / Power source

19. REPLACEMENT PARTS

When replacement parts are required, be sure the service technician uses replacement parts specified by the manufacturer or those that have the same characteristics as the original part. Unauthorized substitutions may result in fire, electric shock or other hazards.

20. SAFETY CHECK

Upon completion of any service or repairs to this unit, ask the service technician to perform safety checks to determine that the unit is in proper operating condition.

21. HEAT

The product should be situated away from heat sources such as radiators, heat registers, stoves, or other products (including amplifiers) that produce heat.

22. DISC TRAY

Keep your fingers well clear of the disc tray as it is closing. It may cause serious personal injury.

23. CONNECTING

When you connect the product to other equipment, turn off the power and unplug all of the equipment from the wall outlet. Failure to do so may cause a product damage. Read the owner's manual of the other equipment carefully and follow the instructions when making any connections.

24. LASER BEAM

Do not look into the opening of the disc tray or ventilation opening of the product to see the source of the laser beam. It may cause sight damage.

25. DISC

Do not use a cracked, deformed, or repaired disc. These discs are easily broken and may cause serious personal injury and product malfunction.

26. NOTE TO CABLE TV SYSTEM INSTALLER

This reminder is provided to call the Cable TV system installer's attention to Article 820-40 of the NEC that provides guidelines for proper grounding and, in particular, specifies that the cable ground shall be connected to the grounding system of the building, as close to the point of cable entry as practical.

WARNING

Handling the cord on this product or cords associated with accessories sold with this product, will expose you to lead, a chemical known to the State of California to cause birth defects or other reproductive harm.

Wash hands after handling.

Power source

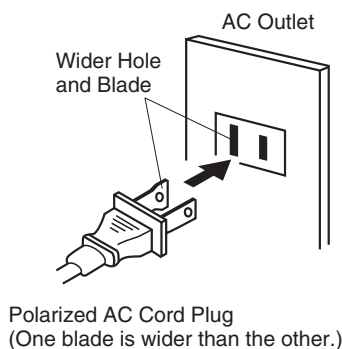

TO USE AC POWER SOURCE

Use the AC polarized line cord provided for operation on AC. Insert the AC cord plug into a standard 120V 60Hz polarized AC outlet.

Notes:

- Never connect the AC line cord plug to other than the specified voltage (120V 60Hz). Use the attached power cord only.
- If the polarized AC cord does not fit into a non-polarized AC outlet, do not attempt to file or cut the blade. It is the user's responsibility to have an electrician replace the obsolete outlet.
- If you cause a static discharge when touching the unit and the unit fails to function, simply unplug the unit from the AC outlet and plug it back in. The unit should return to normal operation.

Precautions

Notes on handling

- When shipping the DVD/VCR, the original shipping carton and packing materials come in handy. For maximum protection, repack the unit as it was originally packed at the factory.
- Do not use volatile liquids, such as insect spray, near the DVD/VCR. Do not leave rubber or plastic products to contact the DVD/VCR for a prolonged period. They will leave marks on the finish.
- The top and rear panels of the DVD/VCR may become warm after a long period of use. This is not a malfunction.
- When the DVD/VCR is not in use, be sure to remove the disc and the video cassette turn off the power.
- If you do not use the DVD/VCR for a long period, the unit may not function properly in the future. Turn on and use the DVD/VCR occasionally.

Notes on locating

- Place the DVD/VCR on a level surface. Do not use it on a shaky or unstable surface such as a wobbling table or inclined stand. The loaded disc or the video tape may become dis-aligned and damage the DVD/VCR.
- When you place this DVD/VCR near a TV, radio, or VCR, the playback picture may become poor and the sound may be distorted. In this case, place the DVD/VCR away from the TV, radio or VCR.

Notes on cleaning

Use a soft, dry cloth for cleaning.

- Use a dry cloth to wipe.
Do not use any type of solvent, such as thinner and benzene, as they may damage the surface of the DVD/VCR.
- If you use a chemical saturated cloth to clean the unit, follow that product's instructions.

Note on moisture condensation

Moisture condensation damages the DVD/VCR. Please read the following carefully.

Moisture condensation occurs, for example, when you pour a cold drink into a glass on a warm day. Drops of water form on the outside of the glass. In the same way, moisture may condense on the head drum or the optical pick-up lens inside this unit, one of the most crucial internal parts of the DVD/VCR.

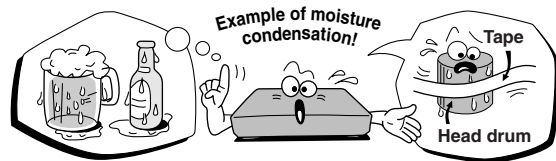

■ **Moisture condensation occurs during the following cases.**

- When you bring the DVD/VCR directly from a cold place to a warm place.
- When you use the DVD/VCR in a room where you just turned on the heater, or a place where the cold wind from the air conditioner directly hits the unit.
- In summer, when you use the DVD/VCR in a hot and humid place just after you move the unit from an air conditioned room.
- When you use the DVD/VCR in a humid place.

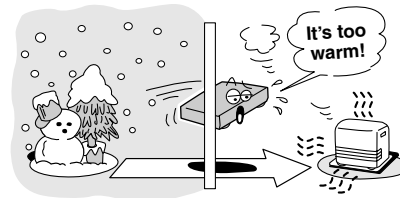

■ **Do not use the DVD/VCR when moisture condensation may occur.**

If you use the DVD/VCR in such a situation, it may damage discs and internal parts. Remove the disc or the video tape, connect the power cord of the DVD/VCR to the wall outlet, turn on the DVD/VCR, and leave it for two or three hours. After two or three hours, the DVD/VCR will have warmed up and evaporated any moisture. Keep the DVD/VCR connected to the wall outlet and moisture condensation will seldom occur.

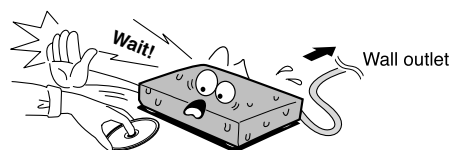

Notes on discs

On handling discs

- Do not touch the playback side of the disc.

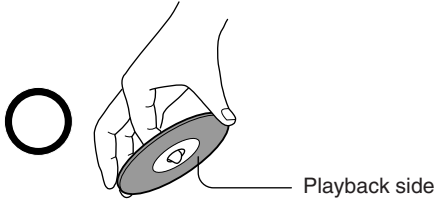

- Do not attach paper or tape to discs.



On cleaning discs

- Fingerprints and dust on the disc cause picture and sound deterioration. Wipe the disc from the center outwards with a soft cloth. Always keep the disc clean.

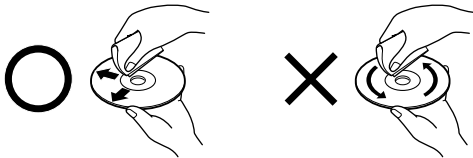

- Do not use any type of solvent such as thinner, benzene, commercially available cleaners or antistatic spray for vinyl LPs. It may damage the disc.

On storing discs

- Do not store discs in a place subject to direct sunlight or near heat sources.
- Do not store discs in places subject to moisture and dust such as a bathroom or near a humidifier.
- Store discs vertically in a case. Stacking or placing objects on discs outside of their case may cause warping.

Structure of disc contents

Normally, DVD video discs are divided into titles, and the titles are sub-divided into chapters. VIDEO CDs and audio CDs are divided into tracks.

DVD video disc

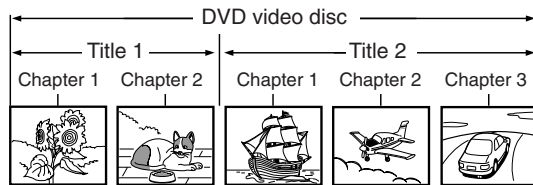

Video CD/Audio CD

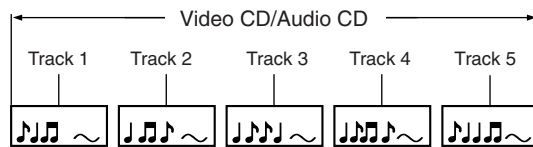

Each title, chapter or track is assigned a number, which is called "title number", "chapter number" or "track number" respectively.

There may be discs that do not have these numbers.

Notes on copyright

The unauthorized recording, use, distribution, or revision of television programs, videotapes, DVDs and other materials, is prohibited under the Copyright Laws of the United States and other countries, and may subject you to civil and/or criminal liability.

This product incorporates copyright protection technology that is protected by U.S. patents and other intellectual property rights. Use of this copyright protection technology must be authorized by Macrovision, and is intended for home and other limited viewing uses only unless otherwise authorized by Macrovision. Reverse engineering or disassembly is prohibited.

Consumers should note that not all high definition television sets are fully compatible with this product and may cause artifacts to be displayed in the picture. In case of 525 progressive scan picture problems, it is recommended that the user switch the connection to the "STANDARD DEFINITION" output. If there are questions regarding our TV set compatibility with this model 525p DVD player, please contact our customer service center.

Notes on discs (Continued)

About this owner's manual



This owner's manual explains the basic instructions of this DVD/VCR. Some DVD video discs are produced in a manner that allows specific or limited operation during playback. As such, the DVD/VCR may not respond to all operating commands. This is not a defect in the DVD/VCR. Refer to instruction notes of discs.

The following symbol may appear on the TV screen during operation.

It means that the operation is not permitted by the DVD/VCR or the disc.

For example, sometimes it is unable to stop the playback of copyright message of the disc when the STOP (■) button is pressed. Alternatively, this symbol may also indicate that the feature is not available for the disc.

Notes on region numbers

The region number of this DVD/VCR is 1. If region numbers, which stand for their playable area, are printed on your DVD video disc and you do not find  or , disc playback will not be allowed by the player. (In this case, the DVD/VCR will display a message on-screen.)

On Video CDs

This DVD/VCR supports Video CDs equipped with the PBC (Version 2.0) function. (PBC is the abbreviation of Playback Control.) You can enjoy two playback variations depending on types of discs.

- **Video CD not equipped with PBC function (Version 1.1)**

Sound and movie can be played on this DVD/VCR in the same way as an audio CD.

- **Video CD equipped with PBC function (Version 2.0)**

In addition to operation of a Video CD not equipped with the PBC function, you can enjoy playback of interactive software with search function by using the menu displayed on the TV screen (Menu Playback). Some of the functions described in this owner's manual may not work with some discs.

Playable discs

This DVD/VCR can play the following discs.

| | Disc Mark | Contents | Disc Size | Maximum playback time |
|-----------------|--|---------------------------------|------------------|---|
| DVD video discs |  | Audio + Video (moving pictures) | 12 cm | Approx. 4 hours (single sided disc) |
| | | | | Approx. 8 hours (double sided disc) |
| |  | | 8 cm | Approx. 80 minutes (single sided disc) |
| | | | | Approx. 160 minutes (double sided disc) |
| Video CDs |  | Audio + Video (moving pictures) | 12 cm | Approx. 74 minutes |
| | | | 8 cm | Approx. 20 minutes |
| Audio CDs |  | Audio | 12 cm | Approx. 74 minutes |
| | | | 8 cm (CD single) | Approx. 20 minutes |

The following discs are also available.

- DVD-R/RW discs of DVD video format
 - CD-R/CD-RW discs of CD-DA, Video CD, SVCD, MP3, WMA, JPEG or DivX® format
 - Kodak Picture CD and FUJICOLOR CD format
- Some of these discs may be incompatible.

- You cannot play discs other than those listed above.
- You cannot play discs of DVD-RAM, DVD-ROM, Photo CD, etc., or non standardized discs even if they may be labeled as above.
- Some CD-R/RWs cannot be played back depending on the recording conditions.
- This DVD/VCR uses the NTSC color system, and cannot play DVD video discs recorded in any other color system (PAL, SECAM, etc.).

Because of problems and errors that can occur during the creation of DVD and Video CD software and/or the manufacture of DVD and Video CD discs, Toshiba cannot guarantee that this DVD/VCR will play every feature of every DVD bearing the DVD logo and/or every Video CD bearing the CD logo. As one of the creators of DVD technology, Toshiba DVD players are manufactured using the highest standards of quality, and as a result, such incompatibilities are rare. If you happen to experience any difficulty playing a DVD or a Video CD on this DVD/VCR, please feel free to call our Contact listed in "How to Obtain Warranty Services" [69](#).

 is a trademark of DVD Format/Logo Licensing Corporation.



Contents

Introduction

| | |
|----------------------------------|----|
| SAFETY PRECAUTIONS | 2 |
| IMPORTANT SAFEGUARDS | 3 |
| Power source | 5 |
| Precautions | 6 |
| Notes on discs | 7 |
| Contents | 9 |
| Identification of controls | 10 |

Connections

| | |
|--|----|
| Antenna connections | 14 |
| Cable TV connections | 16 |
| Connecting to a TV | 18 |
| Connecting to optional audio equipment | 20 |

Basic setup (VCR)

| | |
|---------------------------------|----|
| Setting the video channel | 22 |
| Setting the language | 23 |
| Clock setting | 24 |
| Tuner setting | 27 |

Playback (VCR)

| | |
|---|----|
| Loading and unloading a cassette tape | 29 |
| Cassette tape playback | 30 |
| Special playback | 31 |
| Convenience function | 32 |

Recording (VCR)

| | |
|---------------------------------------|----|
| Recording a TV program | 34 |
| One-touch Timer Recording (OTR) | 36 |
| Timer recording | 37 |

Other functions (VCR)

| | |
|-------------------------------------|----|
| Stereo recording and playback | 39 |
| Second Audio Program (SAP) | 39 |
| Duplicating a video tape | 40 |
| Recording a DVD/CD disc | 41 |

Basic playback (DVD)

| | |
|----------------------|----|
| Playing a disc | 42 |
|----------------------|----|

Advanced playback (DVD)

| | |
|---|----|
| Zooming | 45 |
| Locating desired scene | 45 |
| Marking desired scenes | 46 |
| Repeat playback | 47 |
| A-B Repeat playback | 47 |
| Program playback | 48 |
| Random playback | 48 |
| Changing angles | 49 |
| Title selection | 49 |
| DVD menu | 49 |
| Changing soundtrack language | 50 |
| Setting surround sound | 50 |
| Subtitles | 51 |
| To turn off the PBC | 51 |
| MP3/WMA/JPEG/DivX® and Audio CD operation | 52 |

Function setup (DVD)

| | |
|---|----|
| Customizing the function settings | 58 |
| Temporary disabling of rating level by DVD disc | 64 |

Others

| | |
|--------------------------|----|
| Language code list | 65 |
| Troubleshooting | 66 |
| Specifications | 67 |
| Limited warranty | 68 |

Introduction



Identification of controls

See the page in for details.

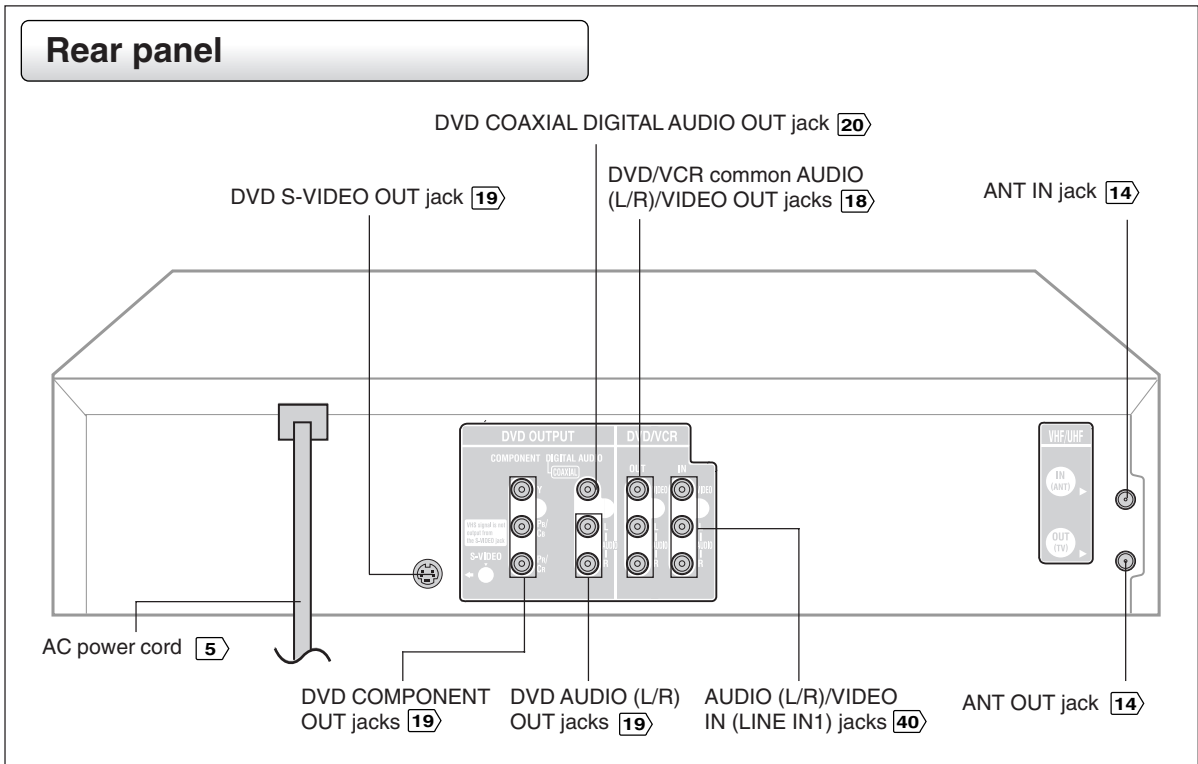
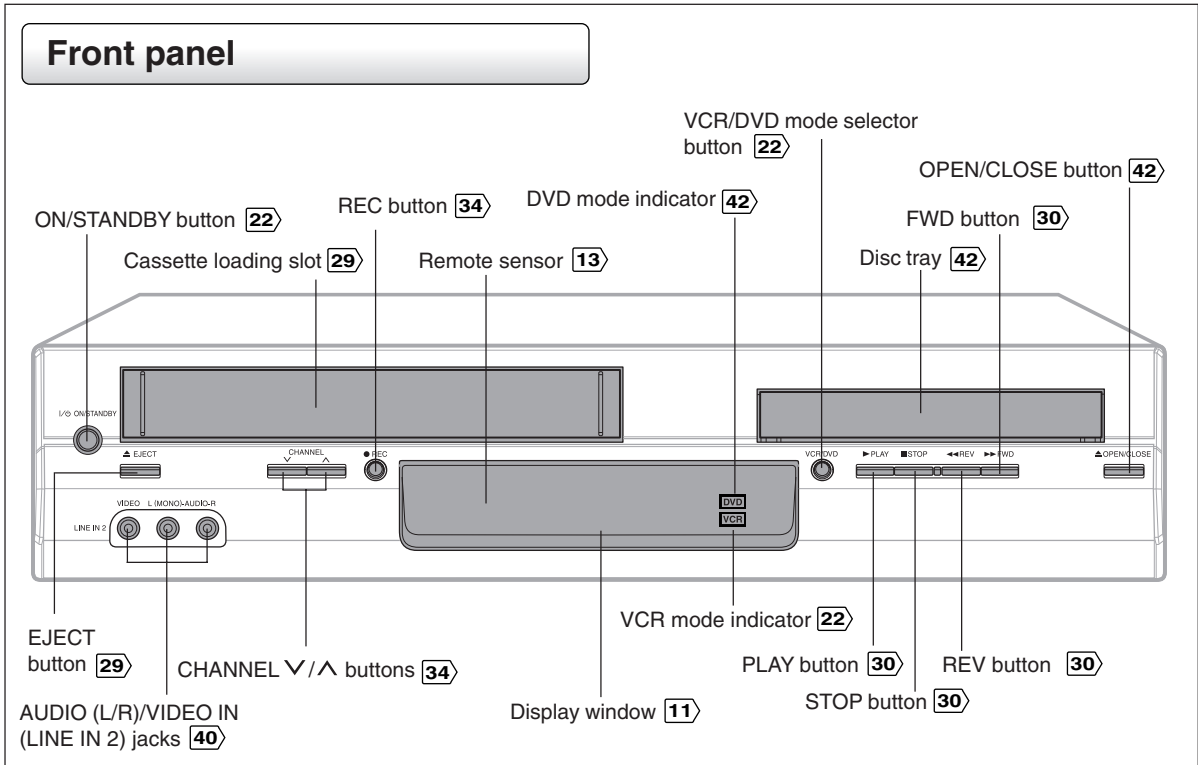



Display window

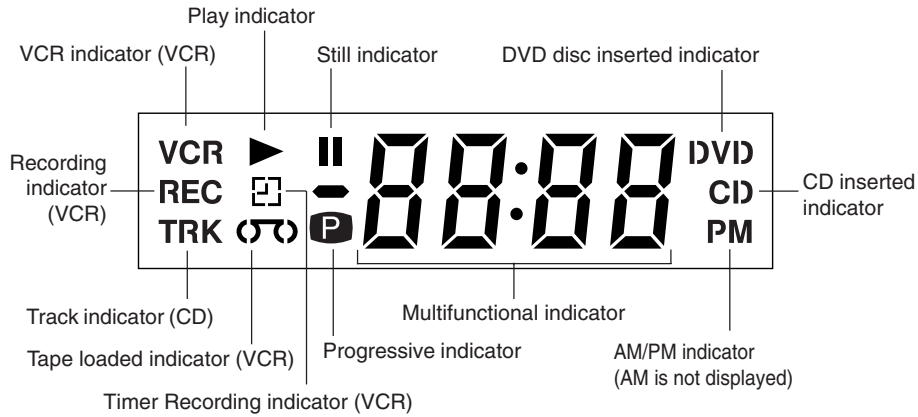

VCR operation status

Press **CALL** to display VCR operation status on the screen.
To cancel the display, press **CALL** again.

While watching TV

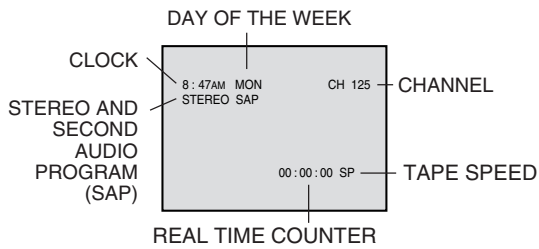

While operating a tape

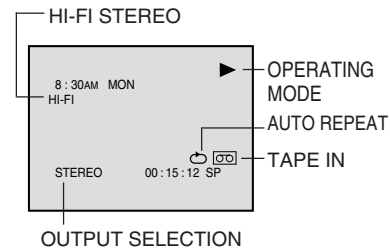

VCR Icons

- Recording : ●
- Rec/Pause : ●||
- Play : ►
- Stop : ■
- Eject : ▲

Disc operation status

Press **DISPLAY**, the status display of the disc will appear on the screen as follows.
To cancel the display, press **DISPLAY** again.

DVD

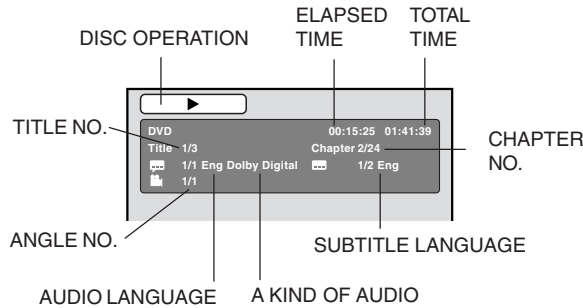

VCD

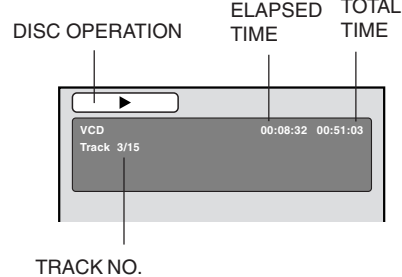

Identification of controls (Continued)

The instructions in this manual describe the functions on the remote control. See the page in for details.

Remote control

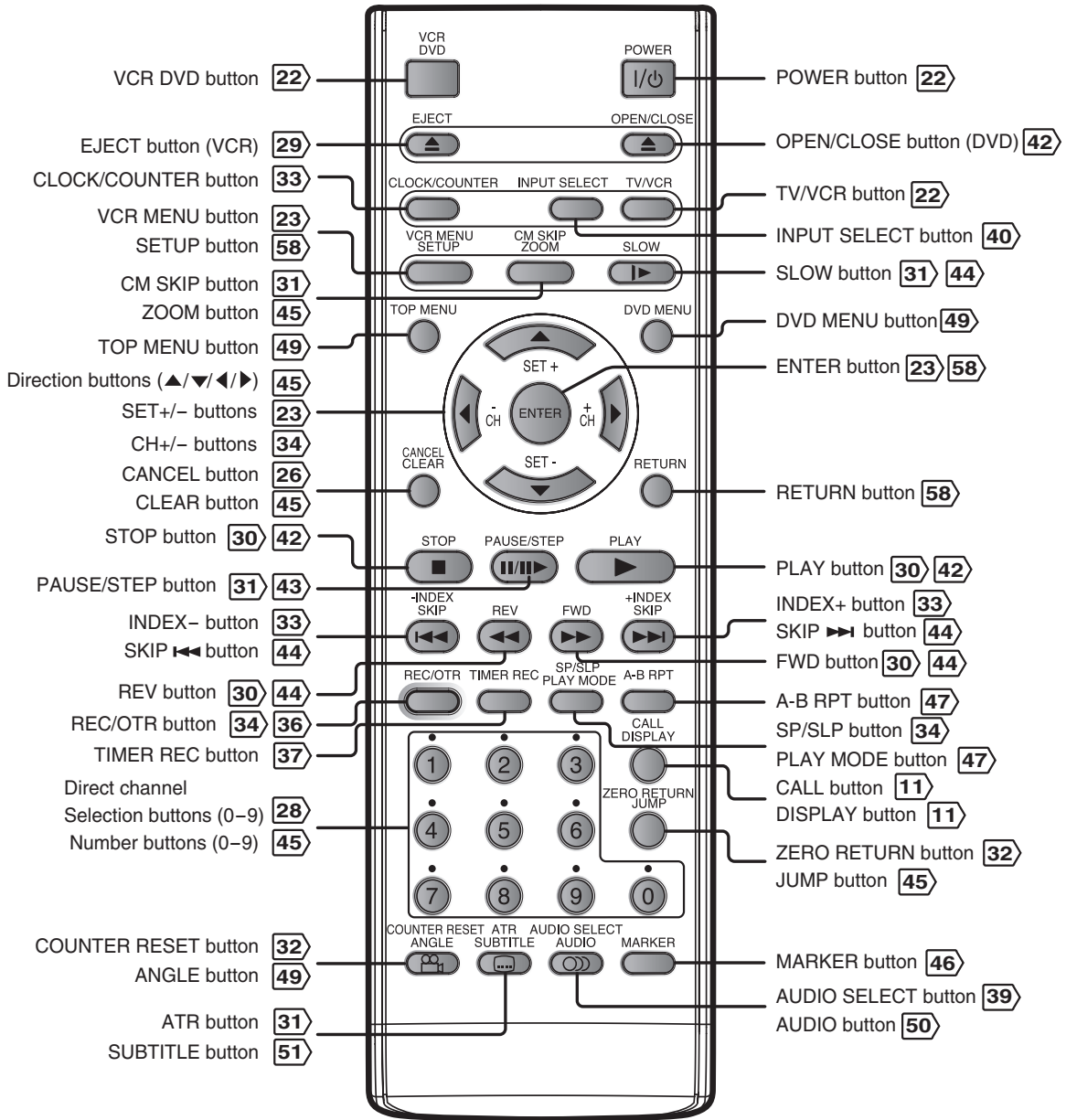

DVD MENU button

Use the DVD MENU button to display the menu included on many DVD video discs. To operate a menu, follow the instructions in "DVD Menu." 49



Inserting batteries

- 1** Open the battery compartment cover in the direction of the arrow.

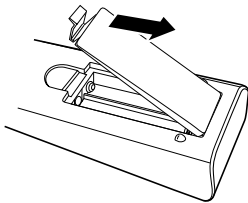

- 2** Install two “AAA” batteries (supplied), paying attention to the polarity diagram in the battery compartment.

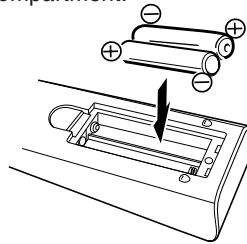

- 3** Replace the compartment cover.

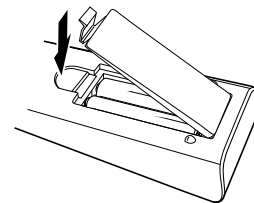
**Caution:**

Never throw batteries into a fire.

Notes:

- Be sure to use AAA size batteries.
- Dispose of batteries in a designated disposal area.
- Batteries should always be disposed of with the environment in mind. Always dispose of batteries in accordance with applicable laws and regulations.
- If the remote control does not operate correctly, or if the operating range becomes reduced, replace batteries with new ones.
- When necessary to replace batteries in the remote control, always replace both batteries with new ones. Never mix battery types or use new and used batteries in combination.
- Always remove batteries from remote control if they are dead or if the remote control is not to be used for an extended period of time. This will prevent battery acid from leaking into the battery compartment.

Remote control basics

- Press **POWER** to turn the DVD/VCR on or off.
- Select your desired operating mode (DVD or VCR) using **VCR DVD**. (DVD or VCR indicator on the front panel will show you which mode is selected.)
- Press **CH +** or **CH -** to move through the channels one channel at a time.
- The **▲/▼/◀/▶** are also used to navigate on-screen menu system.
- You can directly access specific channels using **Direct channel selection buttons (0-9)**.
- Each press of **VCR DVD** on the remote control, switches the screen between the VCR screen (VCR mode) and the DVD screen (DVD mode).

Operation

- Aim the remote control at the remote sensor and press control buttons to operate.
- Operate the remote control within 30° angle on either side of the remote sensor, up to a distance of approx. 7 meters.

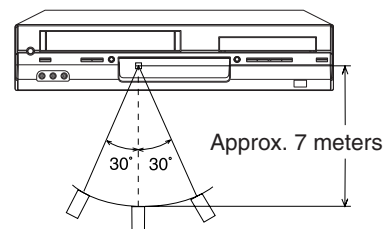

Antenna connections

If you are using an antenna system, follow these instructions. If you are a Cable TV subscriber, skip ahead to page 16 for the proper connections.

Antenna to DVD/VCR connection

The DVD/VCR must be connected “between” the antenna and the TV. First, disconnect the antenna from the TV and connect it to the DVD/VCR. Then connect the DVD/VCR to the TV. Below are 3 common methods of connecting an antenna system to a DVD/VCR. Find the type of antenna system you are using and follow the connection diagram.

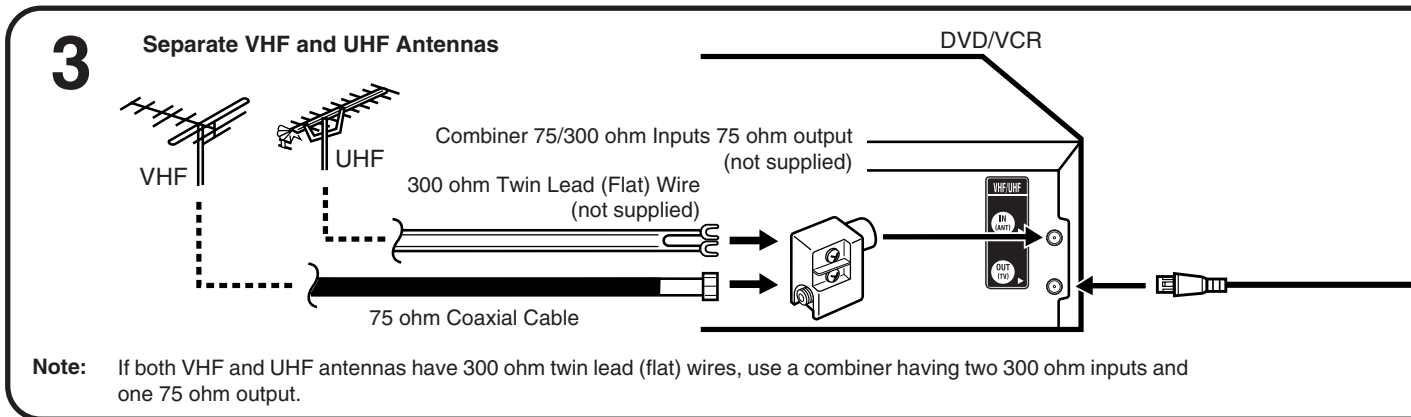
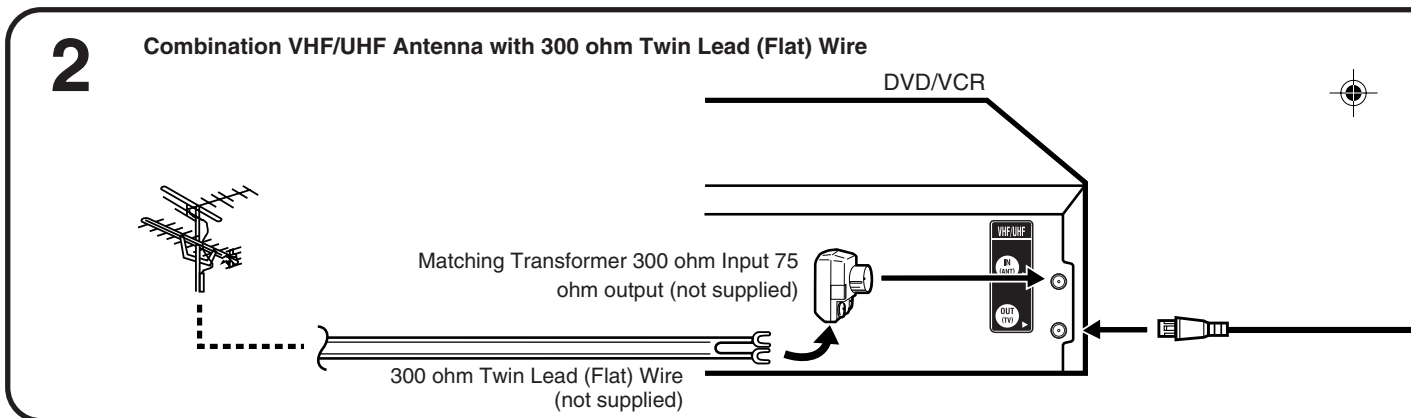
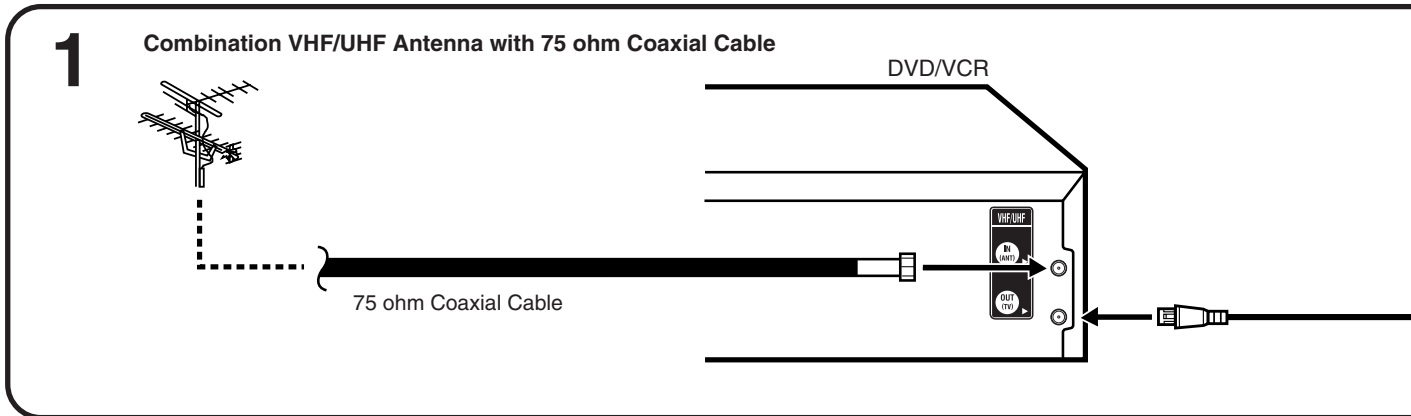

Note: If both VHF and UHF antennas have 300 ohm twin lead (flat) wires, use a combiner having two 300 ohm inputs and one 75 ohm output.

- Notes:**
- A clear picture will not be obtained by the DVD/VCR unless the antenna signal is good. Connect the antenna to the DVD/VCR properly.
 - For better quality recording, an indoor antenna or a telescopic antenna is not recommended. The use of an outdoor type antenna is required.
 - If you are not sure about the connection, please refer to qualified service personnel.



DVD/VCR to TV connection

After you have connected the antenna to the DVD/VCR, you must connect the DVD/VCR to the TV. Below are 3 common methods of connecting your DVD/VCR to a TV. Find the type of TV you are using and follow the connection diagram.

This DVD/VCR has a single 75 ohm output for connection to a TV. If your TV has separate VHF and UHF antenna inputs (numbers 2 and 3 below), use a splitter to connect the DVD/VCR to the TV for VHF and UHF reception.

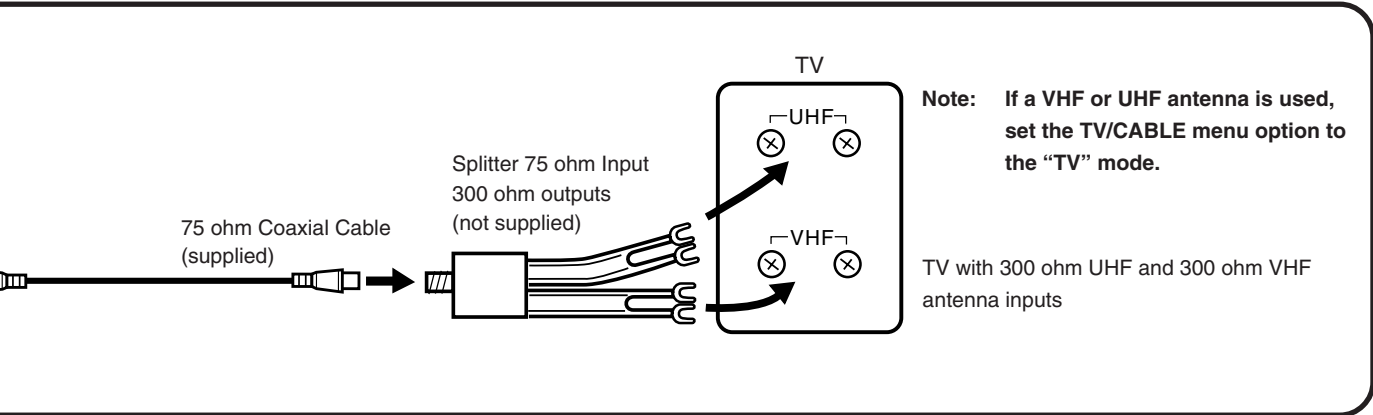
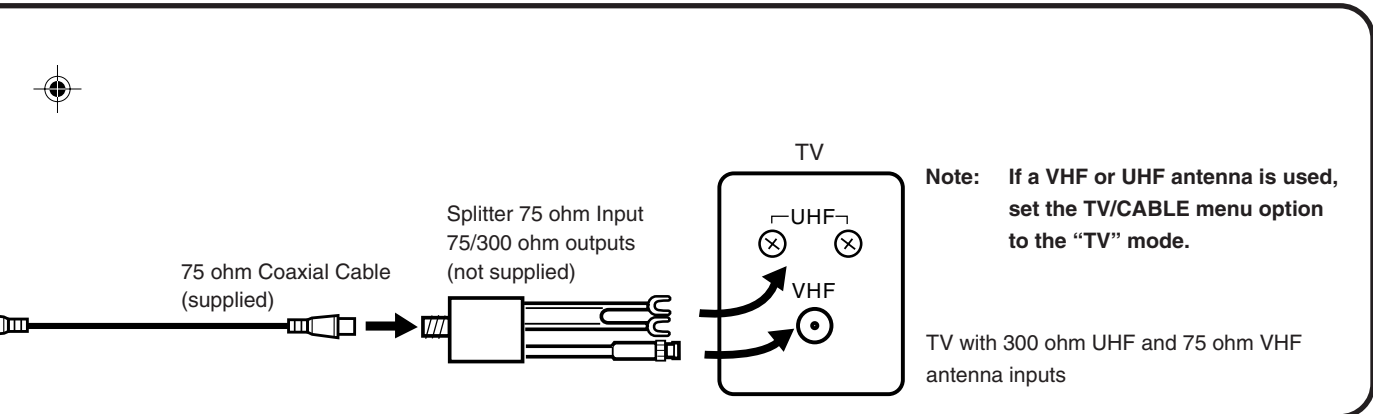
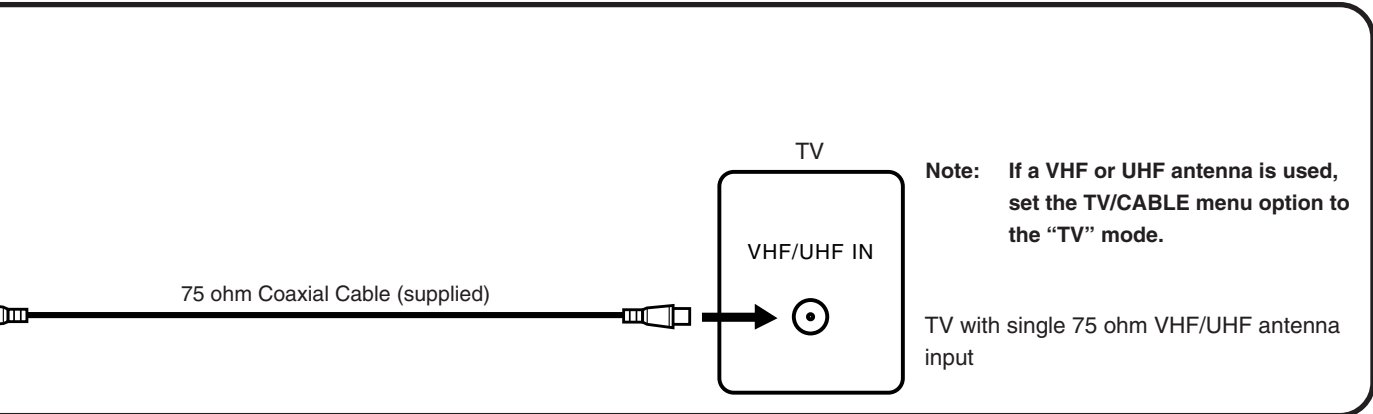

Cable TV connections

Many cable companies offer services permitting reception of extra channels including pay or subscription channels. This DVD/VCR has an extended tuning range and can be tuned to most cable channels without using a cable company supplied converter box, except for those premium channels which are intentionally scrambled. If you subscribe to a premium channel which is scrambled, you must have a descrambler box for proper reception.

1

DVD/VCR

Incoming Cable

TV

VHF/UHF IN (ANT)

VHF/UHF OUT (ANT)

Allows:

- * Recording of nonscrambled channels.
- * Use of the programmable timer.
- * Recording of one channel while watching another.

2

DVD/VCR

Incoming Cable

Converter/Descrambler

TV

VHF/UHF IN (ANT)

VHF/UHF OUT (ANT)

Allows:

- * Recording of channels through the converter box (scrambled and unscrambled).
- * Using the programmable timer to record only the channel selected at the converter box.

Prevents:

- * Recording one channel while watching another.
- * Using the DVD/VCR tuner to select channels.

Note:

To record from converter/descrambler, DVD/VCR tuner must be tuned to the converter output channel, usually channel 3 or 4.

3

DVD/VCR

Incoming Cable

Converter/Descrambler

TV

VHF/UHF IN (ANT)

VHF/UHF OUT (ANT)

Allows:

- * Recording of nonscrambled channels.
- * Use of the programmable timer.
- * Recording an unscrambled channel while watching any channel selected at the converter box.

Prevents:

- Recording scrambled channels.

Note:

If you are playing a tape or using the tuner built into the DVD/VCR, the converter must be set to the video channel output of the DVD/VCR (either 3 or 4).

Note: Whenever a Converter/Descrambler box is placed before the DVD/VCR, you must tune the DVD/VCR to the output of the Converter/Descrambler box, usually channel 3 or 4.



IMPORTANT: Make sure the TV/CABLE menu option is set to the "CABLE" mode.

This DVD/VCR cannot receive scrambled programs since it does not contain a descrambler. In order to receive scrambled programs, your existing descrambler must be used. Descrambler boxes are available from cable companies. Consult your local cable company for more information concerning connection to their descrambler equipment. There are many ways to connect your DVD/VCR to a cable system. Below are six common methods of connection.

4

Allows:

- * Recording of one channel while watching another.
- * Using the programmable timer to record only the channel selected at the converter box.
- * Recording of all channels through the converter box.

Prevents:

- * Watching scrambled channels while recording another channel.
- * Using the DVD/VCR tuner to select channels.

5

Allows:

- * Recording of nonscrambled channels.
- * Recording of one channel while watching another.
- * Watching premium channels through the converter while recording nonscrambled channels.
- * Using the programmable timer.

Prevents: Recording scrambled channels.

6

Allows:

- * Recording of all channels through the converter box.
- * Recording a scrambled or unscrambled channel while watching another (scrambled or unscrambled) channel.
- * Using the programmable timer to record only the channel selected at the converter box.

Prevents: Using the DVD/VCR tuner to select channels.



Connecting to a TV

Connect the DVD/VCR to your TV.

Note: This method transports VHS and DVD-video signals. For enhanced DVD-video performance, we recommend you connect the S-video or ColorStream® component video outputs to your TV/monitor also. [19](#)

Basic connection

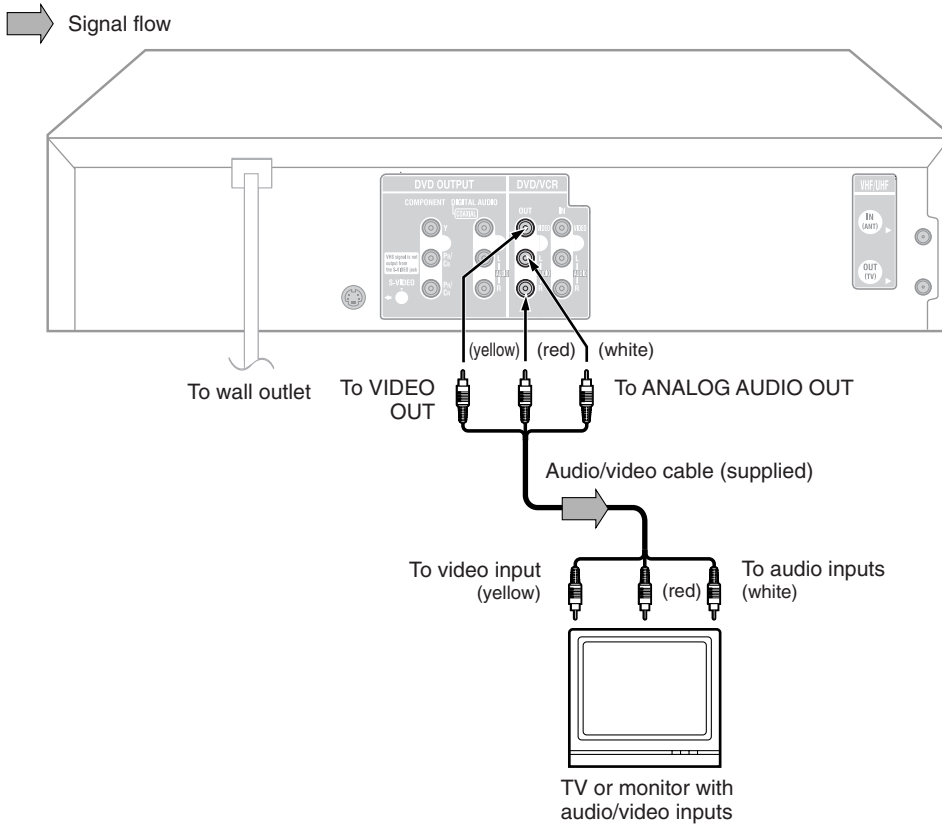

Notes:

- Refer to the owner's manual of the connected TV as well.
- When you connect the DVD/VCR to your TV, be sure to turn off the power and unplug both units from the wall outlet before making any connections.
- If your television set has one audio input, connect the left and right audio outputs of the DVD/VCR to a Y cable adapter (not supplied) and then connect to your TV.
- Connect the DVD/VCR directly to your TV. If you connect the DVD/VCR to a VCR, TV/VCR combination or video selector, the playback picture may be distorted as DVD video discs are copy protected.





■ S-video output

An S-Video connection is superior to Video (Yellow) output. Use this method for DVD playback when the connected television has S-Video input, and does not have component video inputs.

■ Component video outputs

PROGRESSIVE outputs

Some TVs or monitors are equipped with component video inputs that are capable of reproducing a progressively scanned video signal. Connecting to these inputs allows you to view the highest quality pictures with less flicker.

INTERLACED outputs

Some TVs or monitors are equipped with component video inputs. Connecting to these inputs allows you to enjoy the highest quality DVD picture playback.

Notes:

- To switch the scan mode between the interlace and progressive modes, see page 63.
- In some TVs or monitors, the color levels of the playback picture may be reduced slightly or the tint may change. In such a case, adjust the TV or monitor for optimum performance.

Connecting to an audio system and TV equipped with S-video input/component video inputs

The S-video output and component video output transports the DVD-video signal exclusively and will deliver enhanced DVD video picture performance.

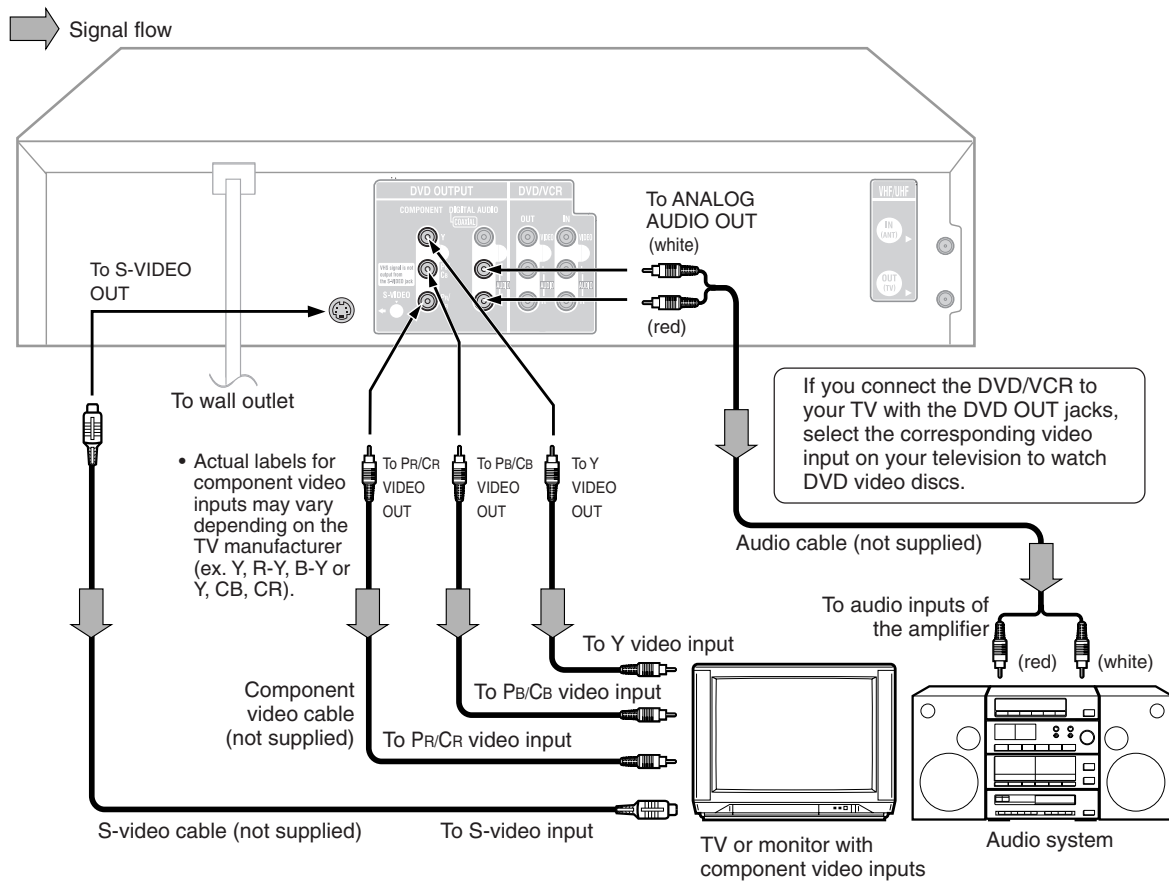

Notes:

- Refer to the owner's manual of the connected equipment as well.
- When you connect the DVD/VCR to other equipment, be sure to turn off the power and unplug all of the equipment from the wall outlet before making any connections.
- If you place the DVD/VCR near a tuner or radio, the radio broadcast sound might be distorted. In this case, place the DVD/VCR away from the tuner and radio.
- The output sound of the DVD/VCR has a wide dynamic range. Be sure to adjust the receiver's volume to a moderate listening level. Otherwise, the speakers may be damaged by a sudden high volume sound.
- Turn off the amplifier before you connect or disconnect the DVD/VCR's power cord. If you leave the amplifier power on, the speakers may be damaged.
- **When connecting to a TV using the S-video jack, make sure that the Progressive indicator "P" on the display window is not lit. If it is lit, the S-video outputs do not feed the correct signals and you cannot see any picture. To turn off the Progressive indicator, select Interlaced output 63.**







Connecting to optional audio equipment

You can enjoy high quality dynamic sounds of DVD video discs or audio CDs by connecting the DVD/VCR to optional audio equipment.

Connection for video signal to your TV, see **18/19**.

• This selection uses the following reference mark.

- | | |
|---|--|
|  : Front speaker |  : Center speaker |
|  : Rear speaker |  : Signal flow |
|  : Sub woofer | |

Connecting to an amplifier equipped with a Dolby Digital decoder

Dolby Digital

Dolby Digital is the surround sound technology used in theaters showing the latest movies, and is now available to reproduce this realistic effect in the home. You can enjoy motion picture and live concert DVD video discs encoded via the Dolby Digital recording system with this dynamic realistic sound by connecting the DVD/VCR to a 6 channel amplifier equipped with a Dolby Digital decoder or Dolby Digital processor. If you have a Dolby Pro Logic Surround decoder, you will obtain the full benefit of Pro Logic from the same DVD movies that provide full 5.1-channel Dolby Digital soundtracks, as well as from titles with the Dolby Surround mark.

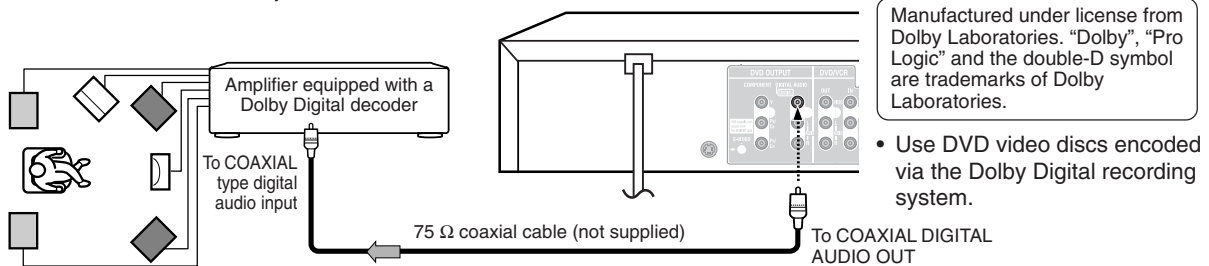

Connecting to an amplifier equipped with Dolby Surround Pro Logic

Dolby Surround Pro Logic

You can enjoy the dynamic realistic sound of Dolby Surround Pro Logic by connecting an amplifier and speaker system (right and left front speakers, a center speaker, and one or two rear speakers).

- With an amplifier equipped with Dolby Digital
Connect the equipment the same way as described in "Connecting to an amplifier equipped with a Dolby Digital decoder." Refer to that amplifier's owner's manual and set the amplifier so that you can enjoy Dolby Surround Pro Logic sound.
- With an amplifier not equipped with Dolby Digital
Connect the equipment as follows.
 - This connection is only suitable for Video CDs and Audio CDs.

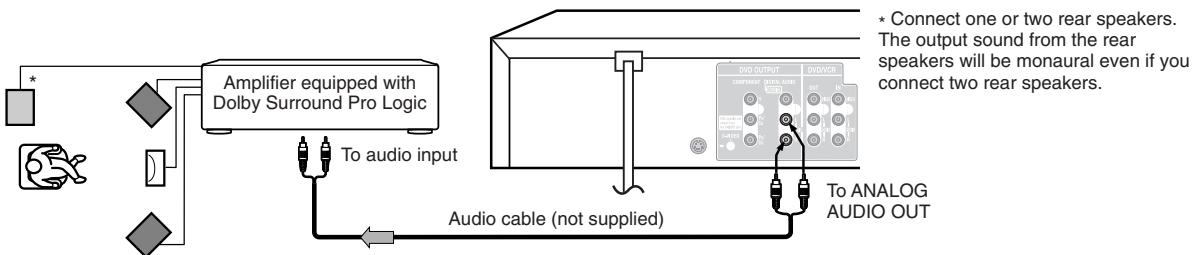

Connecting to an amplifier equipped with a DTS decoder

Digital Theater Systems (DTS)

DTS is a high quality surround technology used in theaters and now available for home use, on DVD video discs or audio CDs. If you have a DTS decoder or processor, you can obtain the full benefit of 5.1 channel DTS encoded sound tracks on DVD video discs or audio CDs.

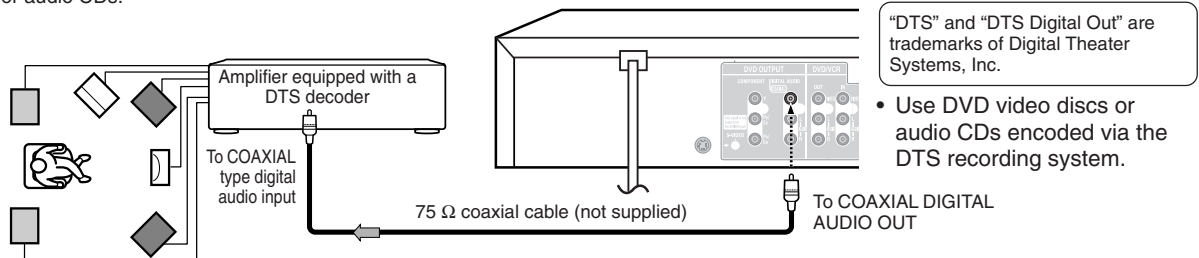



Warning

When playing DTS-encoded discs (DVD video disc and audio CDs), excessive noise may be output from the analog stereo jacks. To avoid possible damage to the audio system, you should take proper precautions when the ANALOG AUDIO OUT (L/R) jacks of the DVD/VCR are connected to an amplification system. (Do not leave the ANALOG AUDIO OUT (L/R) wires dangling.) To enjoy DTS Digital Surround™ playback, an external 5.1 channel DTS Digital Surround™ decoder system must be connected to the COAXIAL DIGITAL AUDIO OUT jack of the DVD/VCR.

Connecting to an amplifier equipped with an MPEG2 audio decoder

MPEG2 sound

You can enjoy motion picture and live concert DVD video discs encoded via the MPEG2 recording system with dynamic realistic sound by connecting an amplifier equipped with an MPEG2 audio decoder or MPEG2 audio processor.

- Use DVD video discs encoded via the MPEG2 recording system.

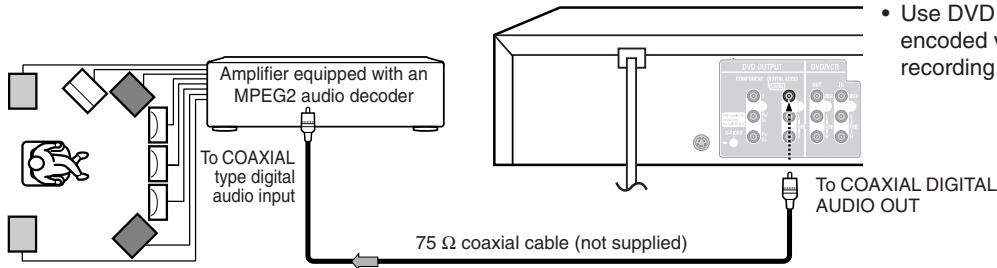

Connecting to an amplifier equipped with a digital audio input

2 channel digital stereo

You can enjoy the dynamic sound of 2 channel digital stereo by connecting an amplifier equipped with a digital audio input and speaker system (right and left front speakers).

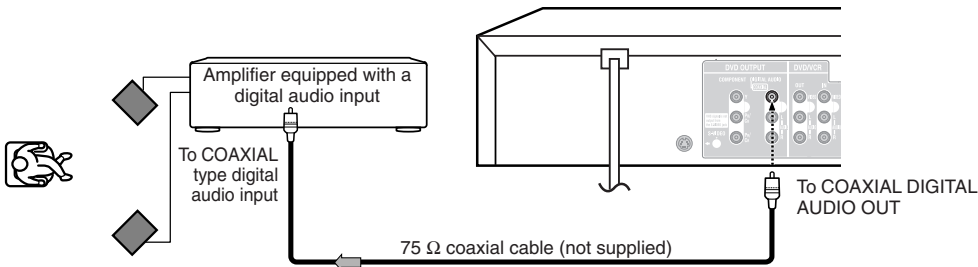

Notes:

- DO NOT connect the COAXIAL DIGITAL AUDIO OUT jack of the DVD/VCR to the AC-3 RF input of a Dolby Digital Receiver. This input on your A/V Receiver is reserved for Laserdisc use only and is incompatible with the COAXIAL DIGITAL AUDIO OUT jack of the DVD/VCR.
- Connect the COAXIAL DIGITAL AUDIO OUT jack of the DVD/VCR to the "COAXIAL" input of a Receiver or Processor.
- Refer to the owner's manual of the connected equipment as well.
- When you connect the DVD/VCR to other equipment, be sure to turn off the power and unplug all of the equipment from the wall outlet before making any connections.
- The output sound of the DVD/VCR has a wide dynamic range. Be sure to adjust the receiver's volume to a moderate listening level. Otherwise, the speakers and your hearing may be damaged by a sudden high volume sound.
- Turn off the amplifier before you connect or disconnect the DVD/VCR's power cord. If you leave the amplifier's power on, the speakers may be damaged.

Setting the video channel

When a TV is connected with the 75 ohm coaxial cable only. To view playback of a recorded tape or DVD disc, or to watch a program selected by the VCR's channel selector, the TV must be set to channel 3 or 4 (video channel).

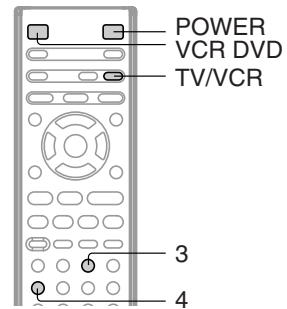

Setting the video channel

1 Press and hold 3 or 4 on the remote for 3 seconds in standby mode.

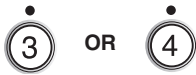

The video channel will start to flash for 3 seconds in the display window.

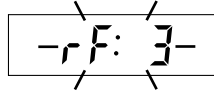

■ For a push-button TV tuner

If CH 3 or 4 corresponding to the video channel cannot be tuned on your TV, proceed as follows: set the VCR 3/4 channel selector and the TV to CH 3 or 4, playback a prerecorded tape and tune the TV to receive a sharp color picture from the video cassette recorder. Refer to your TV owner's manual for details.

Note:

If the unit does not operate properly, or No key operation (by the unit and/or the remote control): Static electricity, etc., may affect the player's operation. Disconnect the AC power cord once, then connect it again.

2 Press POWER to turn on the DVD/VCR.



3 Press VCR DVD selector to select the VCR mode.



The VCR mode indicator will light at the right of the display window.



4 Turn ON the TV and set to CH 3 or 4 to correspond with the channel selected in step 1.

5 Press TV/VCR to select the VCR position.



The VCR indicator will appear at the upper left of the display window.

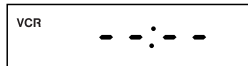

6 Select any channel to receive a TV station in your area. The channel number will appear on the screen for about 4 seconds.

Setting the language

You can choose from three different languages (English, French and Spanish) for the on-screen display.

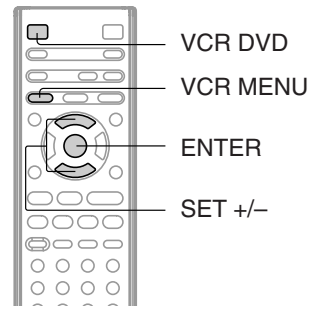

Setting the language

Preparation:

- Turn ON the TV and select to the corresponding video input.
- Press **VCR DVD** selector to select the VCR mode. (The VCR mode indicator will light.)

1 Press VCR MENU.

VCR MENU
SETUP



The VCR menu screen will appear. Press **SET +** or **-** to select "SYSTEM SETUP", then press **ENTER**. If you use the unit for the first time, press **VCR MENU**, instead of the "SYSTEM SETUP" menu screen of the main menu screen in step 2 may appear.

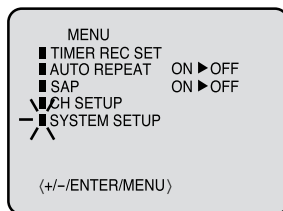

2 Press SET + or - to select "LANGUAGE", then press ENTER.

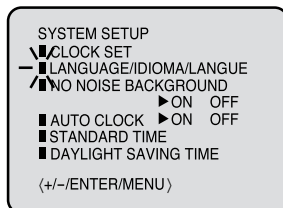
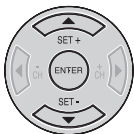

3 Press SET + or - to select the desired language: English (ENGLISH), Spanish (ESPAÑOL) or French (FRANCAIS), then press ENTER.

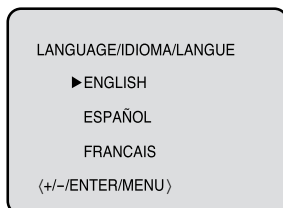

4 Press VCR MENU until the MENU screen is cleared.

VCR MENU
SETUP



Notes:

- Both the VCR and the DVD have their own player menus **58**.
- If no buttons are pressed for more than 60 seconds, the VCR MENU screen will return to normal TV-operation automatically.

Basic setup (VCR)

Clock setting

The AUTO CLOCK function will automatically set the built-in clock (Month, Day, Year and Time) when the DVD/VCR is connected to an Antenna or Cable system and it is turned off. The DVD/VCR searches for a station in your area containing the necessary AUTO CLOCK setting signals. Once received, it will take approximately 4 minutes for the clock to set itself automatically.

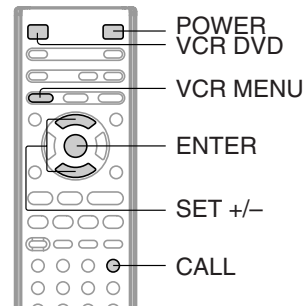

AUTO CLOCK setting

Preparation:

- Turn ON the TV and select the corresponding video input.
- Press **VCR DVD** selector to select the VCR mode. (The VCR mode indicator will light.)

1 Connect the Antenna or Cable system.
• If you use a cable box, turn it on.

2 Plug the AC power cord to the AC outlet.

3 Make sure the DVD/VCR is turned off.
• If you press **POWER**, the Auto Clock set is not programmed.



4 Wait at least three minutes and press **POWER**.



5 Press **CALL** to check the clock setting on the on screen display.

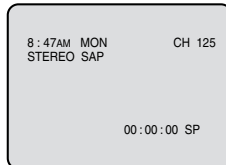

6 If the clock is not set, check the antenna condition. The **AUTO CLOCK** may not function properly if the reception condition is not good.

AUTO CLOCK adjustment

The auto clock adjustment will be updated at 6:00 AM, 12:00 PM and 6:00 PM everyday when the DVD/VCR turned off.

- If you use a cable box and you want **AUTO CLOCK** adjustment to be performed, the cable box must be left on.
- The **AUTO CLOCK** adjustment is not effective when there is a difference of more than 5 minutes exists between the built-in clock time and the actual time.

To set AUTO CLOCK to off

When shipped from factory the **AUTO CLOCK** is set to "ON". But if you do not want **AUTO CLOCK** setting, it can be turned off:

1 Press **VCR MENU**.

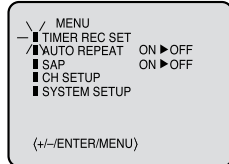

2 Press **SET +** or **-** to select "**SYSTEM SETUP**", then press **ENTER**.

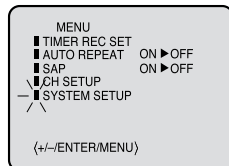
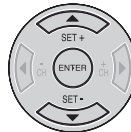

3 Press **SET +** or **-** to select "**AUTO CLOCK**".

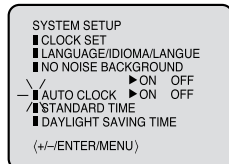

4 Press **ENTER** to select "**OFF**".

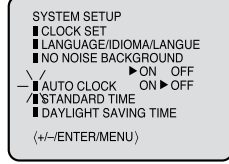

5 Press **VCR MENU** repeatedly to return to the normal screen.





- When the **AUTO CLOCK** is set to "OFF", the **AUTO CLOCK** adjustment does not function. You must set the clock manually [26].

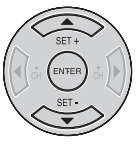
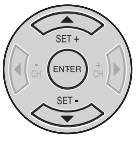

To set STANDARD TIME

In the rare event that you live within broadcast range of two stations in two different time zones, the DVD/VCR may recognize the wrong station for the AUTO CLOCK setting. To correct the situation:



- 1 Press VCR MENU.**
VCR MENU SETUP

- 2 Press SET + or - to select "SYSTEM SETUP", then press ENTER.**

MENU
TIMER REC SET ON ► OFF
AUTO REPEAT ON ► OFF
SAP ON ► OFF
CH SETUP
SYSTEM SETUP
(+/-)ENTER/MENU
- 3 Press SET + or - to select "STANDARD TIME", then press ENTER.**

SYSTEM SETUP
CLOCK SET
LANGUAGE/IDIOM/LANGUE
NO NOISE BACKGROUND
AUTO CLOCK ► ON OFF
STANDARD TIME
DAYLIGHT SAVING TIME
(+/-)ENTER/MENU
- 4 Press SET + or - to select your time zone, then press ENTER.**

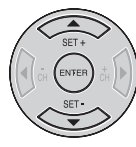
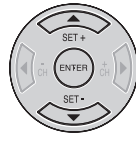
ATLANTIC : GMT-4hours
EASTERN : GMT-5hours
CENTRAL : GMT-6hours
MOUNTAIN : GMT-7hours
PACIFIC : GMT-8hours
ALASKA : GMT-9hours
HAWAII : GMT-10hours
AUTO : AUTO SET
(GMT: Greenwich Mean Time)
- 5 Press VCR MENU until the MENU screen is cleared.**
VCR MENU SETUP

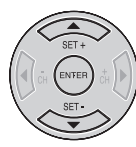
Notes:

- To be able to select the standard time, the clock must first be set by AUTO CLOCK once.
- If you live in Newfoundland and the AUTO CLOCK does not function properly, set the AUTO CLOCK menu option to "OFF" and set the clock manually.

To set DAYLIGHT SAVING TIME

You can set the DAYLIGHT SAVING TIME automatically or manually.

- 1 Press VCR MENU.**
Press SET + or - to select "SYSTEM SETUP", then press ENTER.
VCR MENU SETUP

MENU
TIMER REC SET ON ► OFF
AUTO REPEAT ON ► OFF
SAP ON ► OFF
CH SETUP
SYSTEM SETUP
(+/-)ENTER/MENU
- 2 Press SET + or - to select "DAYLIGHT SAVING TIME", then press ENTER.**

SYSTEM SETUP
CLOCK SET
LANGUAGE/IDIOM/LANGUE
NO NOISE BACKGROUND ► ON OFF
AUTO CLOCK ► ON OFF
STANDARD TIME
DAYLIGHT SAVING TIME
(+/-)ENTER/MENU
- 3 Press SET + or - to select one of the options, then press ENTER. Press VCR MENU until the MENU screen is cleared.**
VCR MENU SETUP

ON: for manual setting (forward one hour)
OFF: for manual setting (back one hour)
AUTO: for automatic setting (read XDS in the signal)
When you want to set the DAYLIGHT SAVING TIME manually, on the first Sunday in April you set to "ON", and on the last Sunday in October you set to "OFF".
DAYLIGHT SAVING TIME
ON
OFF
► AUTO
(+/-)ENTER/MENU

Notes:

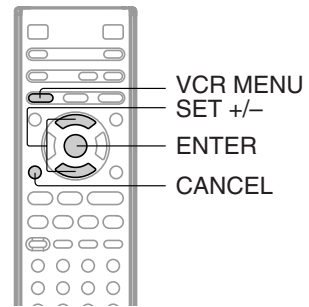
- When shipped from factory, the DAYLIGHT SAVING TIME is set to "AUTO" position.
- When the clock is not set, DAYLIGHT SAVING TIME setting is not available.
- When there is no DAYLIGHT SAVING TIME in your area, always select "OFF" position in step 3.

Clock setting (Continued)

If the AUTO CLOCK process did not set the date and time correctly, you must set them manually for timer recording and DAYLIGHT SAVING TIME.



Manual clock setting

EXAMPLE: Setting the clock to "8:30 AM" March, 25 (SAT), 2006.

1 Press VCR MENU.



2 Press SET + or - to select "SYSTEM SETUP", then press ENTER.

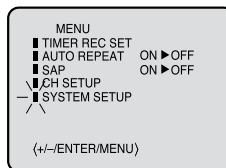

3 Press SET + or - to select "CLOCK SET", then press ENTER.

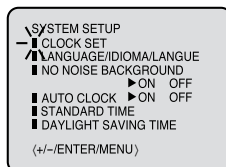
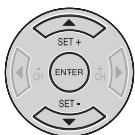

4 Press SET + or - to set the month, then press ENTER.

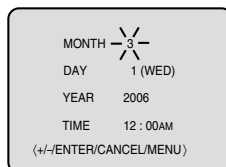
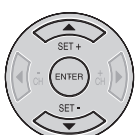

5 Set the day, year and time as in step 4.

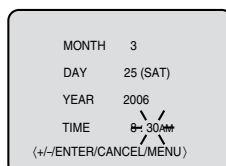

6 After setting the clock, date and time starts functioning automatically.



To make corrections any time during the process
Press **CANCEL** repeatedly until the item you want to change blinks, then press **SET + or -**.

Note:
After a power failure or disconnection of the power, the timer settings will be lost. In this case, reset the present time.

Tuner setting

This DVD/VCR is equipped with a channel memory feature which allows channels to skip up or down to the next channel set into memory, skipping over unwanted channels. Before selecting channels, they must be programmed into the DVD/VCR's memory. In addition to normal VHF and UHF channels, this DVD/VCR can receive up to 113 Cable TV channels. To use this DVD/VCR with an antenna, set the TV/CABLE menu option to the TV mode. When shipped from the factory, this menu option is in the CABLE mode.

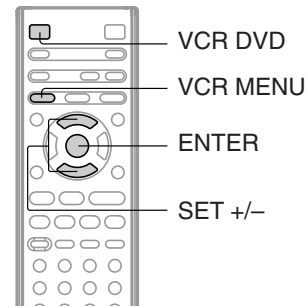

TV/CABLE selection

Preparation:

- Turn ON the TV and select to the corresponding video input.
- Press **VCR DVD** selector to select the VCR mode. (The VCR mode indicator will light.)

- 1 Press VCR MENU. Press SET + or - to select "CH SETUP", then press ENTER.**

VCR MENU
SETUP

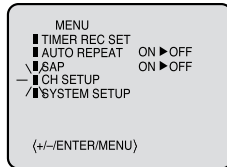
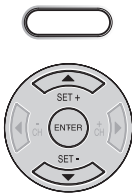

- 2 Press SET + or - to select "TV/CABLE".**

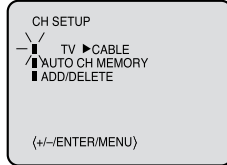

- 3 Press ENTER to select the TV or CABLE mode.**



The arrow indicates the selected mode.

TV - VHF/UHF channels
CABLE - Cable TV channels

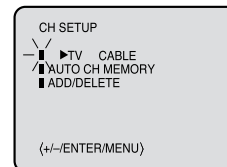

- 4 Press VCR MENU until the menu screen is cleared.**

VCR MENU
SETUP



Note:

You can't select "CH SETUP" if you set the channel to "L1" or "L2".

Setting channels automatically

- 1 Repeat left step 1 and press SET + or - to select "AUTO CH MEMORY".**

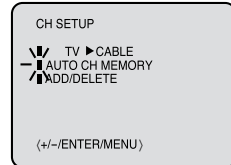
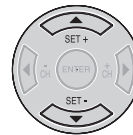

- 2 Press ENTER.**

Auto tuning will begin. The channel display will count up and when finished, the screen returns to normal.

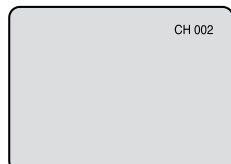

Basic setup (VCR)

Tuner setting (Continued)

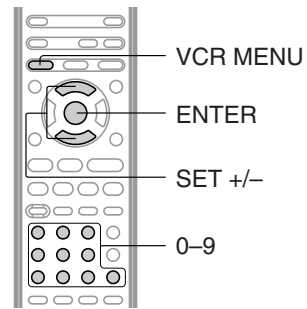

To ADD/DELETE channels

1 Repeat the step 1 on page 27. Then press **SET +** or **-** to select the “ADD/DELETE” and press **ENTER**.

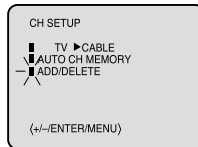

2 To Add or Delete channels

1) Press **Direct channel selection buttons (0-9)** or **SET +/-** to select a channel number you want to add or delete.

2) **To add channels**
Press **ENTER** until “ADD” appears on the screen.
To delete channels
Press **ENTER** until “DELETE” appears on the screen. The channel number will blink.

3) Repeat step 1 and 2 to add or delete other channel.

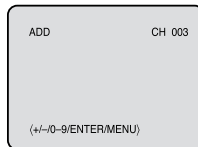
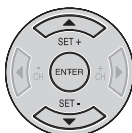
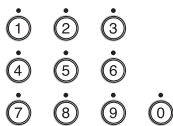

3 Press **VCR MENU** until the menu screen is cleared.



Noise elimination

When you don't want to receive a weak signal broadcast, a Blue back screen can be obtained by selecting the NO NOISE BACKGROUND to “ON”. When the unit is shipped from the factory, the NO NOISE BACKGROUND is set to “ON”.

1 Repeat the steps 1~2 on page 26 and press **SET +** or **-** to select “NO NOISE BACKGROUND”.

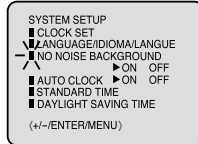
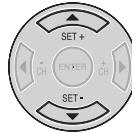

2 Press **ENTER** to select “ON” or “OFF” position.

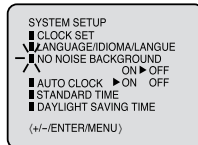

3 Press **VCR MENU** until the menu screen is cleared.



Loading and unloading a cassette tape

Use only video cassette tapes marked **VHS**.

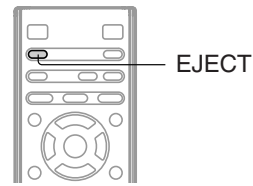

Loading

Push the center of the tape until it is automatically inserted.

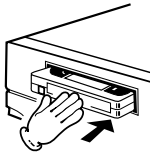

Insert the cassette tape with its labeled side facing up and the erase prevention tab positioned at your left. An inverted cassette tape cannot be inserted.

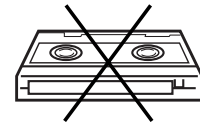
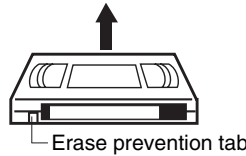

Automatic power ON

When you insert a cassette tape, the DVD/VCR power will turn ON automatically.

Automatic playback

When loading a cassette tape without an erase prevention tab, playback will start automatically.

Unloading

1 Press **EJECT** on the front panel or on the remote.

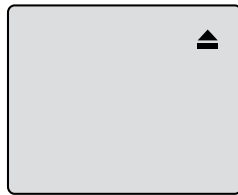
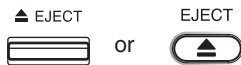

2 Remove the cassette tape.

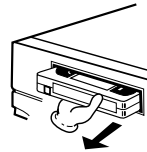

Automatic tape eject

This DVD/VCR will automatically rewind the tape when the tape has ended. Once the tape is rewound to its beginning, the cassette tape will be ejected automatically.

To prevent accidental erasure

To prevent accidental erasure

Remove the erase prevention tab with a screwdriver.

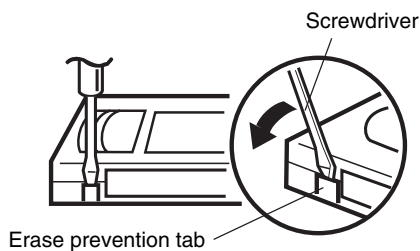

To record again

Cover the hole with a piece of adhesive tape.



Tape speed and maximum recording time

| Tape Speed | Video cassette tape | | | | |
|-----------------------|---------------------|---------|-------------|---------|-------------|
| | T-160 | T-120 | T-90 | T-60 | T-30 |
| SP (Standard Play) | 2-2/3 hours | 2 hours | 1-1/2 hours | 1 hour | 30 minutes |
| SLP (Super Long Play) | 8 hours | 6 hours | 4-1/2 hours | 3 hours | 1-1/2 hours |

Cassette tape playback

To play a prerecorded tape.

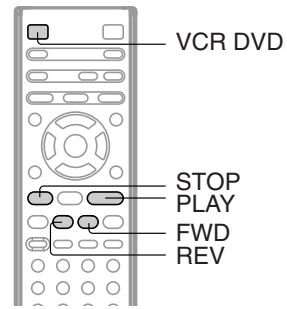

Playback

Preparation:

- Turn ON the TV and select the corresponding video input.
- Press **VCR DVD** selector to select the VCR mode. (The VCR mode indicator will light).

1 Load a prerecorded tape

(When loading a cassette tape without the erase prevention tab, playback will start automatically).

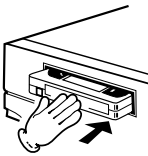

2 To start playback

Press **PLAY**. Playback will start. "▶" will appear on the screen for about 4 seconds.



To stop playback

Press **STOP** once. The tape will stop but remain fully loaded and ready to play. "■" will appear on the screen for about 4 seconds.

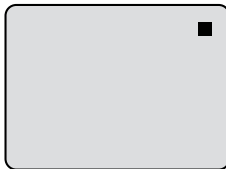

Notes:

- This VCR selects the playback tape speed SP, LP or SLP automatically.
- The Cassette tape and DVD disc can be played back simultaneously. If you press **VCR DVD** selector, the tape playback and DVD playback alternate with each other on the screen (via CH3, 4 or video connection).

Rewind or forward the tape

Stop the playback via **STOP** on remote control.

To rewind the tape:

Press **REV**.

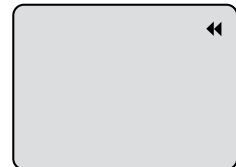

To forward the tape:

Press **FWD**.



To discontinue the tape-winding, press **STOP**. To switch to playback directly (without **STOP**), press **PLAY**.

■ Forward/Reverse picture search mode

When the tape is being winded, you can switch to picture search mode (see page 31). To do this, press **REV** or **FWD** and hold it down. The unit will resume the tape advance or rewinding as soon as the button is released.



Special playback

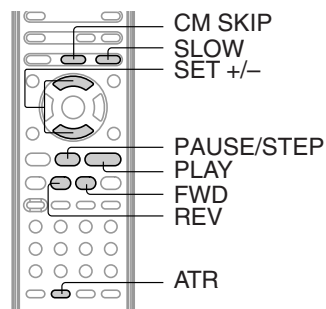

Picture search

Reverse picture search function

Press **REV** once or twice during playback.

Forward picture search function

Press **FWD** once or twice during playback.
To return to playback, press **PLAY**.

SPEED SEARCH TIMES

| TAPE SPEED | PICTURE SEARCH SPEED | |
|-----------------------|----------------------|-------------|
| | PRESS ONCE | PRESS TWICE |
| SP (Standard Play) | 3 X | 5 X |
| LP (Long Play) | 7 X | 9 X |
| SLP (Super Long Play) | 9 X | 15 X |

Still picture

Press **PAUSE/STEP** during playback.
To resume normal playback, press **PLAY** or **PAUSE/STEP**.

Slow motion

During playback press **SLOW**.
To return to playback, press **PLAY** or **SLOW**.

Slow tracking and vertical lock adjustment

If noise bars appear in the picture during slow motion, press the **SET +/-** to reduce the noise bars.
If the still picture jitters excessively, press **SET +/-** to stabilize the still picture.

Frame by frame picture

Press **PAUSE/STEP** during playback.
Press **SLOW** repeatedly. The picture advances frame by frame.
To return to playback, press **PLAY** or **PAUSE/STEP**.

CM skip

Press **CM SKIP** during playback. The DVD/VCR will search forward through approximately 30 seconds of the tape (e.g. unwanted commercial time) for each press of **CM SKIP** (maximum six presses) and then resume normal playback.

For example : 1 press: 30 seconds of tape
2 press: 60 seconds of tape
3 press: 90 seconds of tape

Adjusting tracking condition

Automatic tracking adjustment

Whenever you insert a tape and start playback, the automatic tracking feature continuously analyzes the signal to enable optimum picture quality during playback.

Manual tracking adjustment

If automatic tracking cannot eliminate noises well during playback, press **SET +/-** to eliminate the noise. "MANUAL TR." will appear on the screen. Press it once for a fine adjustment, or press and hold for a coarse adjustment.

Press **ATR** to reactivate automatic tracking again. "AUTO TR." will appear on the screen.

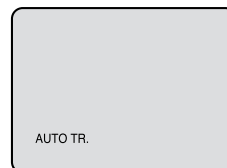

Notes:

- The audio output is muted during PICTURE SEARCH, STILL PICTURE SLOW MOTION and FRAME BY FRAME PICTURE.
- During picture search mode there will be noise bars. This is not a defect.
- Playback will commence after approx. 5 minutes to protect the video tape against excessive wear during pause mode.

Video head cleaning

Video head clogging

The video heads are the means by which the DVD/VCR reads the picture from the tape during playback. In the unlikely event that the heads become dirty enough to be clogged, no picture will be displayed. This can easily be determined if, during playback of a known good tape, there is good sound, but no picture (picture is extremely snowy). If this is the case, the DVD/VCR need to check and clean by the qualified service personnel.



Good Picture



Snowy Picture

Notes:

- DO NOT ATTEMPT TO CLEAN THE VIDEO HEADS OR SERVICE THE UNIT BY REMOVING THE REAR COVER.
- Video heads may eventually wear out and should be replaced when they fail to produce clear pictures.
- To help prevent video head clogging, use only good quality VHS tapes. Discard worn out tapes.

Playback (VCR)

Convenience function

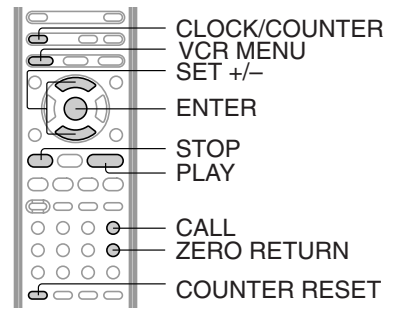

Repeat playback

The entire video tape will play until its end. The tape will automatically rewind to the beginning and the playback will be repeated.

1 Press VCR MENU.

Press **SET +** or **-** to select "AUTO REPEAT".

VCR MENU
SETUP

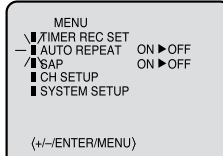

2 Press ENTER to select "ON" or "OFF".

If "ON" is selected, the playback will be repeated endlessly.

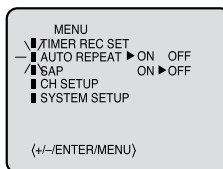

3 Press VCR MENU until the menu screen is cleared.

VCR MENU
SETUP



To confirm whether AUTO REPEAT function is turning ON or OFF, press **CALL**. If "⌂" is displayed, it is turning ON **11**.

4 To commence playback, press PLAY.

The playback will be repeated endlessly.

PLAY



Zero return function

This function rewinds the tape to the "00:00" counter position automatically.

1 Press CLOCK/COUNTER.

The counter display shows the tape running time during playback or recording.

CLOCK/COUNTER



2 Press COUNTER RESET at the desired tape position.

The counter display will be reset to "00:00" position (e.g. the beginning of recording).

COUNTER RESET
ANGLE



3 Press STOP when playback or recording is completed. Press ZERO RETURN.

The tape will automatically rewind or fast forward to the "00:00" counter position.

STOP



ZERO RETURN
JUMP



To cancel repeat mode:

Follow the above step 1, then press **ENTER** to select "OFF" position. Press **VCR MENU** to return to the TV.

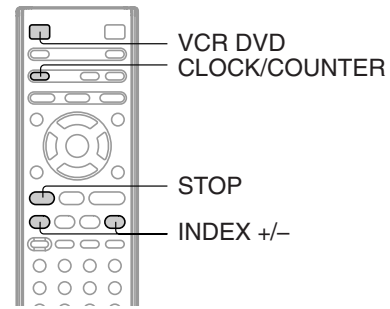

Clock/counter display

Press **CLOCK/COUNTER**. The clock and tape counter alternate with each other in the display window.

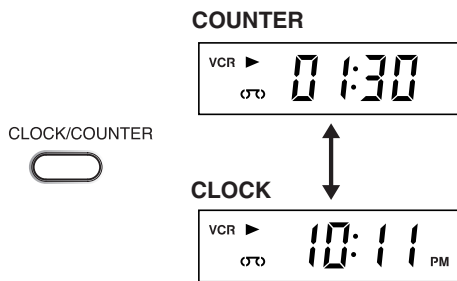

Press **VCR DVD** selector. The DVD mode and the VCR mode alternate with each other in the display.

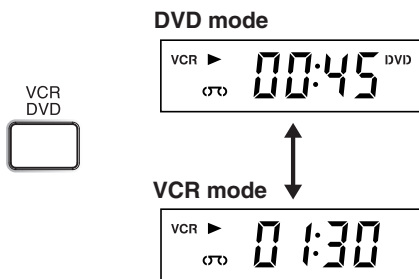

Notes:

- If you rewind the tape beyond "00:00", a minus sign ("-") will be displayed in front of the time.
- When you load a tape, the counter will reset to "00:00".
- The counter does not function on non-recorded (blank) sections of the tape. When you rewind, fast forward or play tapes through blank sections, the counter stops.

Video index search system

This function enables you to locate the beginning of any recording made on the VCR.

Recording an INDEX mark

The Index Search function automatically records an INDEX mark on the tape whenever a recording is initiated.

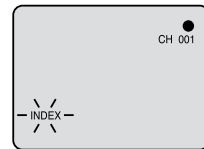

Index search

Press **INDEX +** or **-** during stop or play mode.

For Succeeding programs: Press **INDEX +**.

For Preceding programs: Press **INDEX -**.

(As many as 9 index points can be accessed via this method.)

When the **INDEX +** or **-** is pressed, the unit starts searching the selected INDEX NO. and finds the portion. Then playback starts automatically. To stop the Index Search, press **STOP**.

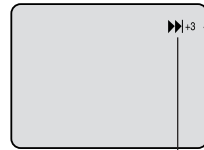

▶▶ or ◀◀ is displayed

INDEX NO. (up to 9)

Notes:

- When you record an INDEX mark at the very beginning of the tape, the mark may not be found.
- During INDEX search, the tape may stop and begin to play at a slightly different location.
- INDEX may not function properly with old or worn out video tapes.
- INDEX marks may not be found if it is extremely close to the point where the search began.
- During recording, if you stop recording temporarily, the INDEX mark is not recorded on the tape.

SQPB (S-VHS Quasi Playback)

You can playback video cassette tapes recorded in the S-VHS system.

However, the picture will not have the high resolution of S-VHS system.

Note: You cannot record S-VHS video format with this VCR.

Playback (VCR)

Recording a TV program

Recording and viewing the same TV program.

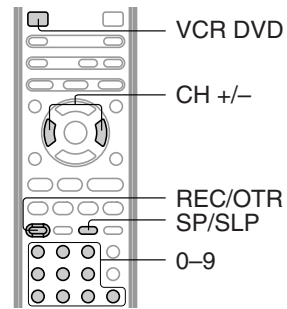

Recording a TV program

Preparation:

- Turn ON the TV and select to the corresponding video input.
- Press **VCR DVD** selector to select the VCR mode. (The VCR mode indicator will light.)

1 Load a cassette tape with the erase prevention tab intact.

The DVD/VCR will automatically turn on.

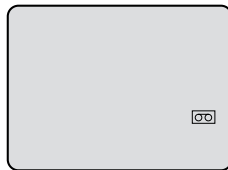
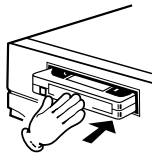

2 Press SP/SLP to select the desired tape speed SP or SLP.

The tape counter and "SP" or "SLP" will appear on the screen for about 4 seconds.

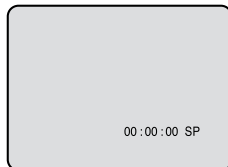

3 Select "TV" or "CABLE" to the appropriate position **27**.

TV - VHF/UHF channels
CABLE - Cable TV channels

4 Press Number buttons or CH +/- to select the channel to be recorded.

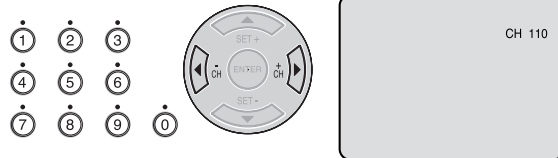

TV mode direct channel selection:

All channels can be instantly selected by using two buttons. (for example, to select channel 2, press "0", then "2". If you press only "2", channel selection will be delayed for two seconds.) For channels 10 and above, press the 2 digits in order.

CABLE mode direct channel selection:

1-9 Press **0** twice and then **1-9** as required.
Example: To select "2", Press **002**.

10-12 Press **0** first and then the remaining 2 digits in order from left to right.

Example: Press **012** for "12".

13-99 Press 2 digits in order.

Example: Press **22** for "22".

100-125 Press the 3 digits in order.
Example: Press **110** for "110".

VHF/UHF/CABLE TV CHANNELS

| TV | CABLE TV |
|--------------|--|
| VHF 2-13 | VHF 2-13 |
| UHF 14-69 | STD/HRC/IRC 14-36 (A) (W) 37-59 (AA) (WW) 60-85 (AAA) (ZZZ) 86-94 (86) (94) 95-99 (A-5) (A-1) 100-125 (100) (125) 01 (5A) |

5 Press REC/OTR.

"●" will appear on the screen for about 4 seconds and "REC" will appear on the display window.



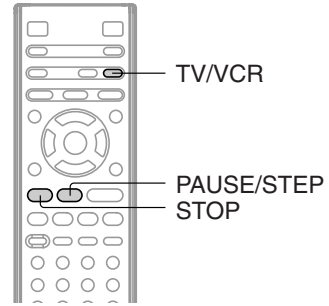

To stop recording

Press **STOP** to stop recording.



“■” will appear on screen for about 4 seconds.

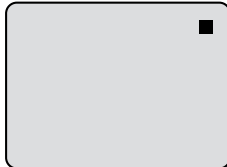

Recording one program while watching another

While the VCR is recording, select your desired channel on the TV.

When a TV is connected with an antenna cable only, press **TV/VCR** to select the TV position. The “VCR” display will go off and recording will continue. Select the TV channel you want to watch by using the TV channel selector.

Note:

Some Cable TV hookups do not permit viewing one channel while recording another. See pages **16** and **17**.



Recording (VCR)

To stop recording temporarily

Press **PAUSE/STEP** to avoid recording unwanted material. Press again to continue the recording.



“●||” will appear on screen for about 4 seconds.



Notes:

- The pause function will be released after 5 minutes to prevent damage to the tape or the VCR. The VCR will change to the STOP mode.
- You can select a recording channel in the recording pause mode.

■ **Auto Rewind feature**

This VCR will automatically rewind the tape when the tape has ended (except during OTR and timer recording). It will also eject the tape.

One-touch Timer Recording (OTR)

The One-touch Timer Recording feature provides a simple and convenient way to make a timed recording.

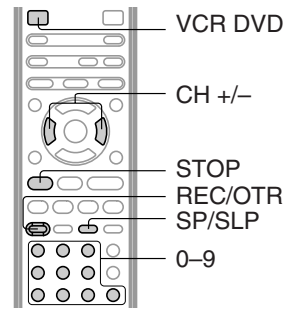

One-touch Timer Recording (OTR)

Preparation:

- Turn ON the TV and select to the corresponding video input.
- Press **VCR DVD** selector to select the VCR mode. (The VCR mode indicator will light.)

Example: One-touch Timer Recording for 30 minutes.

1 Load a cassette tape with the erase prevention tab intact.

The VCR will automatically turn on.

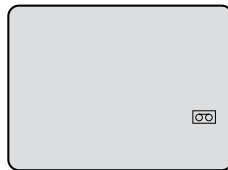
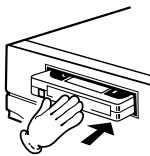

2 Press SP/SLP to select the desired tape speed SP or SLP.

The tape counter and "SP" or "SLP" will appear on the screen for about 4 seconds.

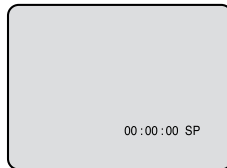

3 Set "TV" or "CABLE" option to the appropriate position [27].

TV - VHF/UHF channels
CABLE - Cable TV channels

4 Press Direct channel selection buttons (0-9) or CH +/- to select the channel to be recorded.

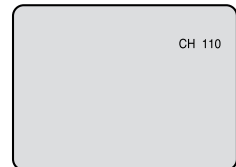
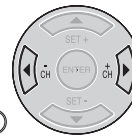
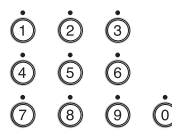

5 Press REC/OTR. Recording begins. Press the button again to stop recording after 30 minutes. Each additional press of REC/OTR will increase recording time as shown in the chart below, up to a maximum of 6 hours.

| Press | Recording time | Press | Recording time |
|---------|----------------|----------|----------------|
| once | NORMAL REC | 6 times | 3:00 |
| twice | 0:30 | 7 times | 4:00 |
| 3 times | 1:00 | 8 times | 5:00 |
| 4 times | 1:30 | 9 times | 6:00 |
| 5 times | 2:00 | 10 times | NORMAL REC |

The OTR and recording time will appear on the screen for about 4 seconds, then change to "●".

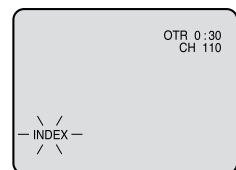

To cancel OTR

Press **STOP** or turn off the power.

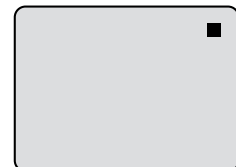

"■" will appear on the screen for about 4 seconds.

Note:

If you wish to watch the DVD playback during OTR or standard recording, press **VCR DVD** selector to change to DVD mode and perform the DVD playback [42].

Timer recording

Timer recording can be programmed on-screen with the remote control. The built-in timer allows automatic unattended recording of up to 8 programs within 1 month.

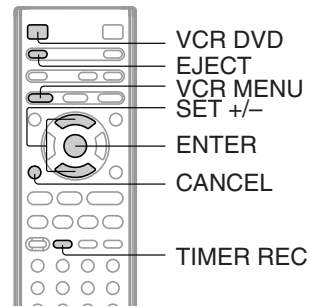

Timer recording

Preparation:

- Press **VCR DVD** selector to select the VCR mode.
- Load a cassette tape with the erase prevention tab intact.
- Check the time and date are correct [24].

Example: Program a timer recording for the 26th day, channel 125 (Cable TV), 11:00 - 11:30 PM on timer program number 1 (Tape speed: SLP).

1 Press VCR MENU. Select "TIMER REC SET", then press ENTER.

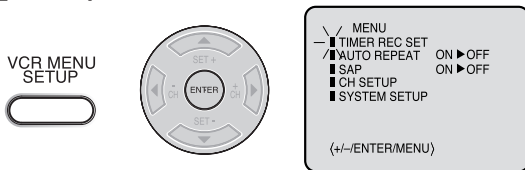

2 Press SET + or - to select one of the program line, then press ENTER.

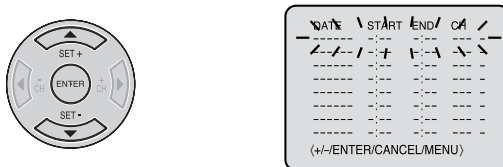

3 Press SET + or - to select the date, then press ENTER.

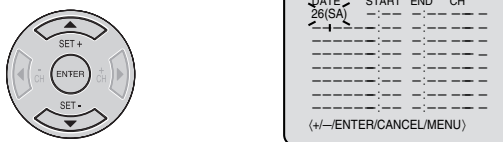

4 Set the start time, end time, channel and tape speed as in step 3.

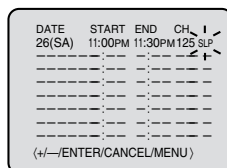

Notes:

- Press **CANCEL** to move cursor backward for correction.
- To record from external source set the channel to "L1" or "L2".

5 To enter other programs, repeat step 2 through 4.

- To return to the normal screen, press **VCR MENU** twice.

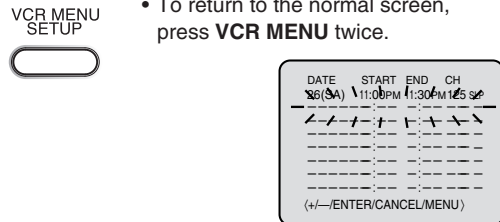

6 Press TIMER REC. The timer symbol (⏺) will appear on the display and the VCR standby for recording.

- At the same time, VCR mode will change to DVD mode automatically. You can use DVD even if the VCR is in the timer recording mode. If you do not use the DVD, turn the power off.

Notes:

- The timer recording will start at 5 seconds before the preset starting time.
- If the timer symbol (⏺) does not appear on the display when **TIMER REC** is pressed, the cassette is not inserted [29].
- If the cassette is ejected when **TIMER REC** is pressed, the erase prevention tab of the cassette may have been removed [29].

Notes:

- If the timer symbol (⏺) blinks when the timer recording ended, the TV program has not been completely recorded because of an insufficient tape length. Press **TIMER REC** to cancel the timer program or press **EJECT** to remove the cassette tape.
- During timer recording standby mode, the VCR mode cannot be operated. To use the VCR, first press **TIMER REC**, then press **VCR DVD** selector to change to VCR mode. After VCR mode is selected, press **TIMER REC** again to put the VCR into timer recording standby mode.
- If you press **TIMER REC** during timer recording, the recording operation will be interrupted. If you press **TIMER REC** again within the programmed time, the recording operation will start again.
- After a power failure or disconnection of the power plug, all programmed recording settings and time display will be lost upon resumption of power. In this case, reset the clock [24] and reprogram any timer recording.

Recording (VCR)

Timer recording (Continued)

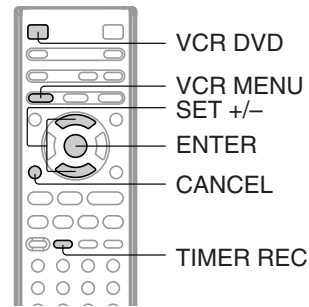

To set daily/weekly timer

Weekly (e.g. WKL-TU: each Tuesday) or daily (e.g. MO-SA: Monday to Saturday) Timer recording

Follow the procedure of timer recording on page 37. At step 3, press **SET +** or **-** repeatedly until the desired setting appears. Then press **ENTER**.

When you press **SET -** repeatedly, the DATE indicator will change as follows, in this case the day is Friday.

The current day (Friday) → SU-SA (Sunday to Saturday)

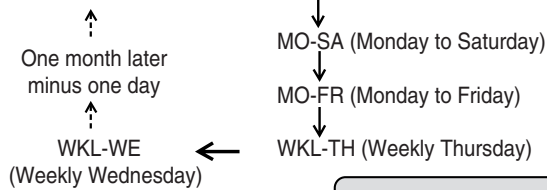

| DATE | START | END | CH |
|--------|-------|------|------|
| WKL-WE | -- | -- | -- |
| ----- | ---- | ---- | ---- |
| ----- | ---- | ---- | ---- |
| ----- | ---- | ---- | ---- |
| ----- | ---- | ---- | ---- |
| ----- | ---- | ---- | ---- |
| ----- | ---- | ---- | ---- |
| ----- | ---- | ---- | ---- |

(+/-/ENTER/CANCEL/MENU)

To confirm or cancel a program

1 If the Timer has been activated, press **TIMER REC** to deactivate the Timer.

The timer symbol (⏻) will disappear. Then press **VCR DVD** selector to change to VCR mode.



2 To confirm Timer program:

At step 1 on page 37 select "TIMER REC SET" and press **ENTER**. The timer program list will appear on the screen.



| DATE | START | END | CH |
|--------|---------|---------|--------|
| 26(SA) | 11:00PM | 11:30PM | 125SLP |
| ----- | ---- | ---- | ---- |
| ----- | ---- | ---- | ---- |
| ----- | ---- | ---- | ---- |
| ----- | ---- | ---- | ---- |
| ----- | ---- | ---- | ---- |
| ----- | ---- | ---- | ---- |
| ----- | ---- | ---- | ---- |

(+/-/ENTER/CANCEL/MENU)

If the programs overlap another

Do not overlap timer programs as portions of the conflicting programs will be lost. The first recording time has priority over the next recording time as shown in the diagram below.

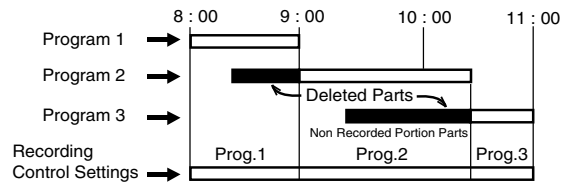

Notes:

- The daily/weekly recording can be made continuously until the recording is canceled or the tape reaches the end.
- During timer recording the automatic rewinding mechanism does not function.

3 To cancel Timer program:

Press **SET +** or **-** to select the unwanted program, then press **CANCEL** to cancel the program.

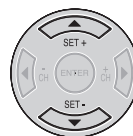

| DATE | START | END | CH |
|-------|-------|------|------|
| ----- | ---- | ---- | ---- |
| ----- | ---- | ---- | ---- |
| ----- | ---- | ---- | ---- |
| ----- | ---- | ---- | ---- |
| ----- | ---- | ---- | ---- |
| ----- | ---- | ---- | ---- |
| ----- | ---- | ---- | ---- |
| ----- | ---- | ---- | ---- |

(+/-/ENTER/CANCEL/MENU)

4 Press **VCR MENU** repeatedly until the menu screen is cleared.



Notes:

- If there are other timer record programs remaining, **TIMER REC** must be pressed to reactivate the timer, otherwise the remaining timer record programs will be ignored.
- You cannot confirm the Timer program during timer recording operation.
- You can correct or cancel a programmed setting in program confirm mode.

Stereo recording and playback / Second Audio Program (SAP)

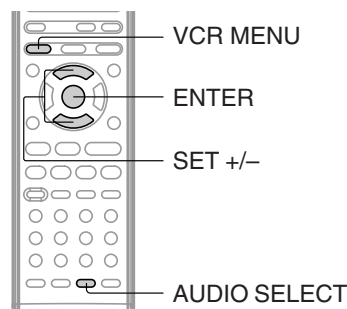

Stereo recording and playback

The VHS Hi-Fi audio system permits high fidelity recording of MTS STEREO TV broadcasts.

When a MTS STEREO broadcast is received, "STEREO" will appear on the screen for about 4 seconds and the program can be viewed or recorded in stereo. The Hi-Fi stereo recording procedure is the same as for normal recordings.

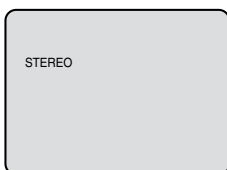

Note:

When using a Cable TV system, stereo TV programs may be transmitted over a mono cable channel. In this case "STEREO" will not appear and the sound will be in mono.



Output selection

When viewing an MTS stereo TV program, or playing a prerecorded VHS Hi-Fi stereo videotape, press **AUDIO SELECT** to select how the audio will be heard through the speakers. Normally set to the Hi-Fi stereo position, this button can be set to the MONO position if the stereo broadcast or videotape audio is of poor quality. The "R" and "L" positions allow the audio from the Right or Left Hi-Fi channel to be heard over both TV speakers. This button has no effect when viewing a MONO videotape or TV program. Each time when you press the button, OUTPUT SELECTION display appears on the screen for several seconds. Refer to the chart below.

| OUTPUT SELECTION | SOUND HEARD ON BOTH SPEAKERS |
|------------------|------------------------------|
| STEREO | STEREO |
| L ch | LEFT CHANNEL AUDIO |
| R ch | RIGHT CHANNEL AUDIO |
| MONO | MONO |

Second Audio Program (SAP)

Your DVD/VCR is fitted with a SAP broadcast system which enables you to switch to a second audio program when viewing a selected channel.

This function applies only when the program is broadcast in multi-languages through the SAP broadcast system.

1 Press VCR MENU. Then press SET + or - to select "SAP".

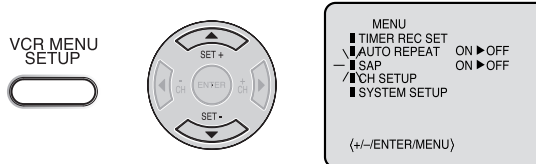

2 Press ENTER to select "ON".

Then press **VCR MENU** until the menu screen is cleared.

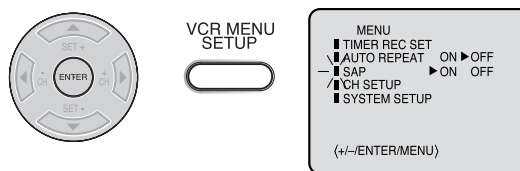

Listening to SAP

When the VCR is turned on or a channel selection is made, make certain the letters "SAP" appears on the screen for about 4 seconds. This means that the "Second Audio Program" broadcasting is available.

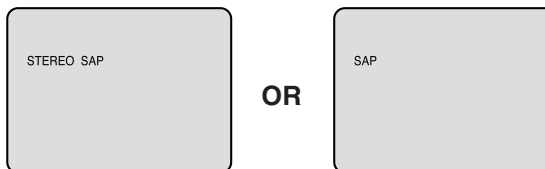

Notes:

- When playing back a tape that is not recorded in Hi-Fi stereo mode, the audio will automatically be monaural.
- When listening to a VHS Hi-Fi video tape or MTS broadcast through the VHF/UHF jack (Audio/Video cable not connected), the sound will be monaural.

Other functions (VCR)

Duplicating a video tape

If you connect the DVD/VCR to another VCR or Camcorder, you can duplicate a previously recorded tape. Make all connections before turning on the power.

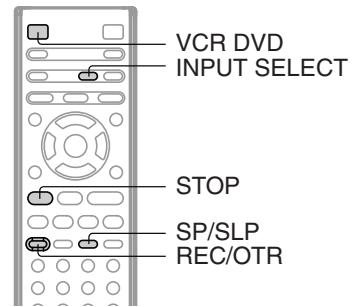

Duplicating a video tape

Preparation:

- Turn ON the TV and select the corresponding video input.
- Press **VCR DVD** selector to select the VCR mode. (The VCR mode indicator will light.)
- Load a cassette tape with the erase prevention tab intact.
- Load a previously recorded tape into the playback VCR or Camcorder.

1 Press SP/SLP to select the desired tape speed SP or SLP.



It is recommended to set the tape speed to the SP mode on the recording VCR for best results.

2 Press INPUT SELECT once or twice to select AUDIO/VIDEO input position.

"L1" or "L2" will appear in the display.



L1: on the rear panel
L2: on the front panel

3 Press PLAY on the playback VCR or Camcorder.

4 Press REC/OTR on the recording VCR.



The duplicating process begins.

5 Press STOP when you finish duplicating.



Connection with second VCR

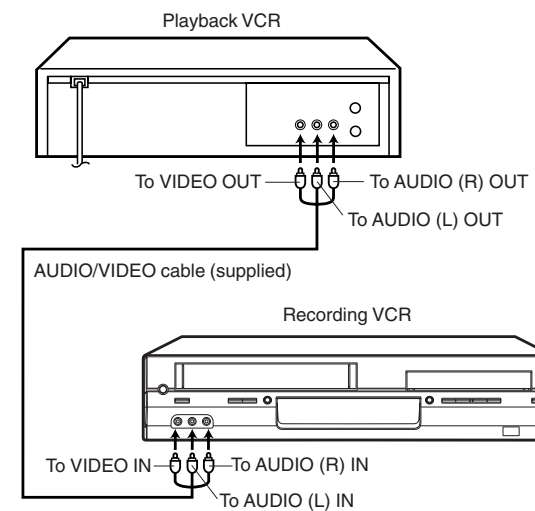

Connection with Camcorder

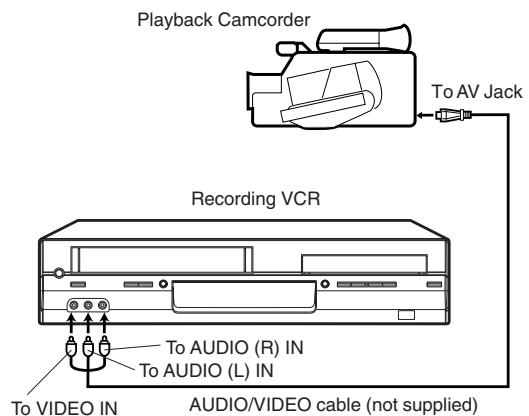

For duplicating a previously recorded tape from a camcorder, follow the camcorder manufacturer's instructions. A typical camcorder dubbing hookup is shown above.



Recording a DVD/CD disc

You can record disc material in DVD, Audio CD, etc. onto a Video tape with this DVD/VCR.

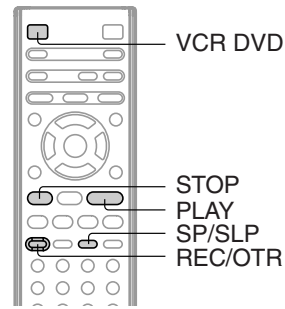

Duplicating a DVD or CD disc

Preparation:

- Turn ON the TV and select the corresponding video input.
- Press **VCR DVD** selector to select the VCR mode. (The VCR mode indicator will light.)
- Load a cassette tape with the erase prevention tab intact.
- Load a DVD/CD disc.

1 Press SP/SLP to select the desired tape speed SP or SLP.

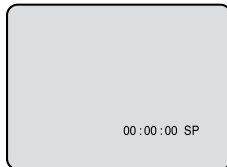

2 Press VCR DVD selector to select the DVD mode. The DVD mode indicator will light.



3 Press PLAY to start playback.



4 Press REC/OTR to start recording.



The DVD/VCR will change to the VCR mode automatically and the playback picture or sound will be duplicated on the video cassette tape.

5 Press STOP when you finish recording.



If you wish to stop a DVD/CD disc, press **VCR DVD** selector to change the DVD mode, then press **STOP**.

Notes:

- You may not be able to record the beginning of the disc. Begin VCR recording once program playback commences on the DVD.
- When the scanning mode is set to the progressive mode, you cannot duplicate a disc material onto a video tape. When **REC/OTR** is pressed, the PROGRESSIVE indicator "P" on the display window will flash.
- You cannot record discs encoded with copy guard function. The following icon and text will show up on the TV screen.



DISC IS COPY PROTECTED

Other functions (VCR)

Playing a disc

This section shows you the basics on how to play a disc.

CAUTION
Keep your fingers well clear of the disc tray as it is closing. Neglecting to do so may cause serious personal injury.

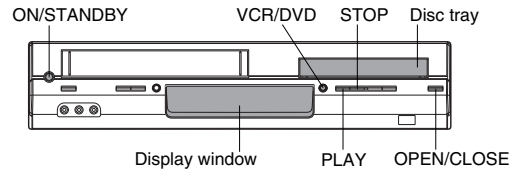

DVD VCD Basic playback



Preparations:

- When you want to view a disc, turn on the TV and select the corresponding video input connected to the DVD. This may include S-video or component video inputs which are exclusive to DVD playback.
- When you want to enjoy the sound of discs from the audio system, turn on the audio system and select the input connected to the DVD/VCR.

1 Press ON/STANDBY.
The DVD/VCR turns on.



2 Press VCR/DVD to select the DVD mode.
The DVD indicator will light.

3 Press OPEN/CLOSE.
The disc tray opens.

4 Place the disc on the disc tray.
With the playback side down

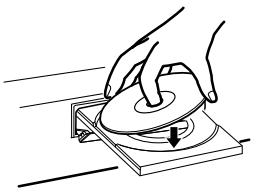

- There are two different disc sizes. Place the disc in the correct guide on the disc tray. If the disc is out of the guide, it may damage the disc and cause the DVD/VCR to malfunction.
- Do not place a disc which is unplayable in this DVD/VCR.

5 Press OPEN/CLOSE or PLAY on the unit.
The disc tray closes automatically. On the TV-screen, "▲" changes to "Reading" and then playback commences.



OR

- A menu screen will appear on the TV screen if the disc has a menu feature.



6 Press ▲/▼ or ◀/▶ to select title.



7 Press ENTER.

- Title is selected and play commences.



8 Press STOP to end playback.

- The unit records the stopped point, depending on the disc. "■" appears on the screen. Press **PLAY** to resume playback (from the scene point).
- If you press **STOP** again or unload the disc ("■" appears on the screen.), the unit will clear the stopped point.



■ To start playback in the stop mode

Press **PLAY**.



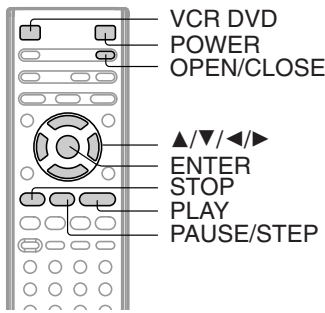

■ To obtain a higher quality picture

Occasionally, some picture noise is not usually visible on the TV screen during a normal broadcast while playing a DVD video disc. It is because due to high resolution pictures on these discs which include a lot of information. The amount of noise depends on the TV you use with this unit. You should generally reduce the sharpness adjustment on your TV when viewing DVD video discs.

■ About

The icons on the heading bar show the playable discs for the function described under that heading.

: You can use this function with DVD video discs.

: You can use this function with Video CDs.

: You can use this function with Audio CDs and CD-R/RW CDs.

■ To pause playback (still mode)

Press **PAUSE/STEP** during playback.



To resume normal playback, press **PLAY**.

- The sound is muted during still mode.

■ To stop playback

Press **STOP**.



■ To remove the disc

Press **OPEN/CLOSE**.



Remove the disc after the disc tray opens completely.

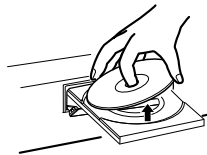

Be sure to press **OPEN/CLOSE** to close the disc tray after you remove the disc.

■ Playing a Disc while the VCR section is recording or standing by for timer recording

- 1) Start to record.
Follow steps 1~5 on page [34](#).
• If the DVD/VCR is standing by for recording, turn on the DVD/VCR.
- 2) Press **VCR DVD** selector to select DVD mode.
- 3) Play a disc.
Follow steps 3 ~ 5 on page [42](#).
• Press **PLAY** if the DVD/VCR does not start to play a disc automatically.
- 4) Stop playback.
Press **STOP** to stop playing a disc.

■ Screen saver function

The screen saver operates when you leave the unit in DVD stop mode for approx. five minutes. The screen will repeatedly get dark gradually and back to normal. Please press any button when you want to return to an usual screen. To turn on or off the screen saver, see page [61](#).

Notes:

- If a non-compatible disc is loaded, "Incorrect Disc", "Region Code Error" or "Parental Error" will appear on the TV screen according to the type of loaded disc. In this case, check your disc again [8](#) [62](#).
- Some discs may take a minute or so to start playback.
- When you set a single-faced disc label downwards (i.e. the wrong way up) and press **OPEN/CLOSE** or **PLAY** on the unit, "Reading" will appear on the display for a few minutes and then "Incorrect Disc" will continue to be displayed.
- Some discs may not work the resuming facility.
- Resuming cannot function when you play a PBC-featured Video CD while the PBC is on. To turn off the PBC, see page [51](#).
- Some playback operations of DVDs may be intentionally fixed by software producers. Since this unit plays DVDs according to the disc contents the software producers designed, some playback features may not be available. Also refer to the instructions supplied with the DVDs.
- Do not move the unit during playback. Doing so may damage the disc.
- Use the **OPEN/CLOSE** to open and close the disc tray. Do not push the disc tray while it is moving. Doing so may cause the unit to malfunction.
- Do not push up on the disc tray or put any objects other than discs on the disc tray. Doing so may cause the unit to malfunction.
- In many instances, a menu screen will appear after playback of a movie is completed. Prolonged display of an on-screen menu may damage your television set, permanently etching that image onto its screen. To avoid this, be sure to press **POWER** on your remote control once the movie is completed.
- There may be a slight delay between the button is pressed and the function activates.

Playing a disc (Continued)

You can play discs at various speeds.

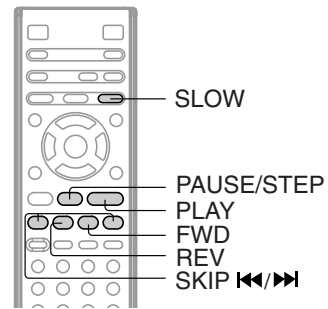

DVD VCD CD Playing in fast reverse or fast forward directions

Press **REV** or **FWD** during playback.



REV: Fast reverse playback
FWD: Fast forward playback

Each time you press **REV** or **FWD**, the playback speed changes.

To resume normal playback

Press **PLAY**.



Notes:

- The DVD/VCR mutes sound and subtitles during reverse and forward scan of DVD/VCD video discs. However, this unit plays sound during fast forward or fast reverse play of audio CDs.
- The playback speed may differ depending on the disc.

DVD VCD Playing frame by frame

Press **PAUSE/STEP** during still playback.



Each time you press **PAUSE/STEP**, the picture advances one frame.

To resume normal playback

Press **PLAY**.



Note:

The sound is muted during frame by frame playback.

DVD VCD Playing in slow-motion

Press **SLOW** during playback.



Each time you press the button, the slow-motion speed changes.

To resume normal playback

Press **PLAY**.



Note:

The sound is muted during slow-motion playback.

DVD VCD CD Locating a chapter or track

Press **SKIP** **◀** or **▶** repeatedly to display the chapter or track number you want.

Playback starts from the selected chapter or track.



To locate succeeding chapters or tracks.



Playback starts from the beginning of the current chapter or track. When you press twice in quick successions, playback starts from the beginning of the preceding chapter or track.

Notes:

- A prohibition symbol "X" may appear at the upper right of the screen. This symbol means either the feature you tried is not available on the disc, or the DVD/VCR cannot access the feature at this time. This does not indicate a problem with the DVD/VCR.
- The unit is capable of holding a still video image or On screen display image on your television screen indefinitely. If you leave the still video image or On screen display image displayed on your TV for an extended period of time, you risk permanent damage to your television screen. Projection televisions are very susceptible.

Zooming/Locating desired scene

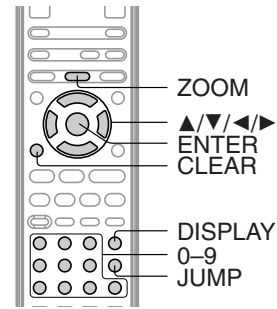

DVD VCD CD Zooming

This unit will allow you to zoom in on the frame image. You can then make selections by switching the position of the frame.

1 Press ZOOM during playback.

CM SKIP ZOOM

The center part of the image will be zoomed in. Each press of **ZOOM** will change the ZOOM Q1 (x 1.3), Q2 (x 1.5) and Q3 (x 2.0).

2 Press ▲/▼/◀/▶ to view a different part of the frame.

SET+ CH ENTER +CH SET- CH

You may move the frame from the center position to UP, DOWN, LEFT or RIGHT direction.

3 In the zoom mode, press ZOOM repeatedly to return to a 1:1 view (Q Off).

CM SKIP ZOOM

- Notes:**
- You can select the Pause, Slow or Search playback in the zoom mode.
 - Some discs may not respond to zoom feature.

DVD VCD CD Locating desired scene

Use the title, chapter and time recorded on the DVD disc to locate the desired point to play back. In the case of VCD/CD discs, time and track are used to locate the desired point to play back. To check the title, chapter and time, press **DISPLAY**.

1 Press JUMP during playback or stop mode.

ZERO RETURN JUMP

| Jump | |
|---------|-------|
| Title | --- |
| Chapter | --- |
| Time | --:-- |

• "Time" only works in playback or resume stop mode.

2 Press ▲ or ▼ to select the "Title", "Chapter" or "Time".

| Jump | |
|---------|-------|
| Title | --- |
| Chapter | --- |
| Time | --:-- |

3 Press Number buttons (0-9) to change the number.

| Jump | |
|---------|-------|
| Title | --- |
| Chapter | 12 |
| Time | --:-- |

• If you input a wrong number, press **CLEAR**.

• Refer to the package supplied with the disc to check the numbers.

4 Press ENTER. Playback starts.

- Notes:**
- In case of the Audio CD and Video-CD, only Track and Time can be selected.
 - In case of the Video-CD playback with PBC, the JUMP does not work. Turn off the PBC [51].

Advanced playback (DVD)

Marking desired scenes

The unit stores the points that you want to watch again up to 3 points. You can resume playback from each scene.

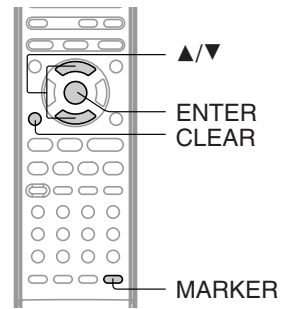

DVD VCD Marking the scenes

- 1 Press MARKER during playback.**

| | |
|---------|--------------|
| Marker1 | -- : -- : -- |
| Marker2 | -- : -- : -- |
| Marker3 | -- : -- : -- |
- 2 Select the blank Marker using ▲ or ▼. Then press ENTER at the desired scene.**

 - Repeat this procedure to set the other 2 scenes.

| | |
|---------|--------------|
| Marker1 | 00 : 27 : 54 |
| Marker2 | -- : -- : -- |
| Marker3 | -- : -- : -- |
- 3 Press MARKER to clear this display.**

| | |
|---------|--------------|
| Marker1 | -- : -- : -- |
| Marker2 | -- : -- : -- |
| Marker3 | -- : -- : -- |

DVD VCD Returning to the scenes

- 1 Press MARKER during playback or stop mode.**

| | |
|---------|--------------|
| Marker1 | 00 : 27 : 54 |
| Marker2 | 01 : 16 : 25 |
| Marker3 | 02 : 08 : 31 |
- 2 Press ▲ or ▼ to select the Marker 1-3.**

| | |
|---------|--------------|
| Marker1 | 00 : 27 : 54 |
| Marker2 | 01 : 16 : 25 |
| Marker3 | 02 : 08 : 31 |
- 3 Press ENTER.**

Playback starts from the marked scene.

■ **To cancel the Marker**
Follow the above steps 1~2, then press **CLEAR**.

Notes:

- Some discs may not work with the marking operation.
- The marking is canceled when you open the disc tray or turn the power off.
- Some subtitles recorded around the marker may fail to appear.



Repeat playback/A-B Repeat playback

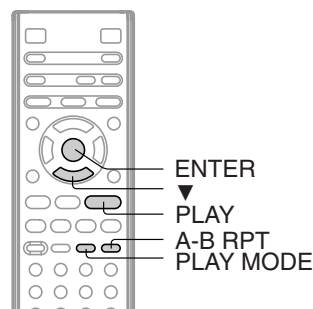

Repeat playback

1 Press **PLAY MODE** during playback or stop mode.

SP/SLP
PLAY MODE

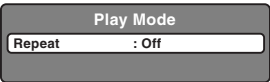

2 [DVD]
Press **ENTER** to select "Chapter" or "Title".

The unit automatically starts repeat playback after finishing the current title or chapter.

[Video CD]
Press **▼** to select "Repeat".
Press **ENTER** to select "Track" or "All".

The unit automatically starts repeat playback after finishing the current track.

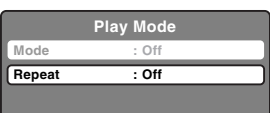
- If you set the repeat mode during stop mode, press **PLAY** to start Repeat playback.

[Audio CD and MP3/WMA CD]
Please see "Repeat playback (CD)"  56.

3 Press **PLAY MODE** again to clear the screen.

■ To resume normal playback

Select Repeat : "Off" in step 2.

Notes:

- Some discs may not work with the repeat operation.
- In case of Video CD with PBC, repeat functions are prohibited during playback.

A-B Repeat playback

A-B repeat playback allows you to repeat material between two selected points.

1 Press **A-B RPT** during playback.

A-B RPT The start point is selected.

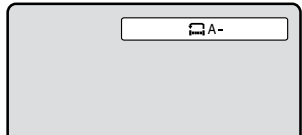
2 Press **A-B RPT** again.

A-B RPT The end point is selected. Playback starts at the point that you selected. Playback stops at the end point, returns to Point A automatically, then starts again.

■ To resume normal playback

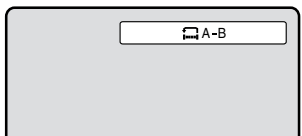
Press **A-B RPT** again.

A-B RPT "Off" appears on the screen.



Notes:

- In A-B Repeat mode, subtitles near the A or B locations may not be displayed.
- You cannot set the A-B Repeat for the scenes that include multiple angles.
- A-B Repeat playback does not work when Repeat playback is activated.
- You may not be able to set A-B Repeat, during certain scenes of the DVD.
- A-B Repeat does not work with an interactive DVD, MP3/WMA/JPEG/DivX® CD.
- A-B Repeat is prohibited when PBC is on.

Advanced playback (DVD)

Program playback/Random playback

You can arrange the playback order of tracks or files on the disc. And the unit can also select tracks or files at random and playback them. These feature works for Video CD.

For Audio CD and MP3/WMA CD, please see "Random playback (CD)" and "Program playback (CD)" [\[56\]](#), [\[57\]](#).

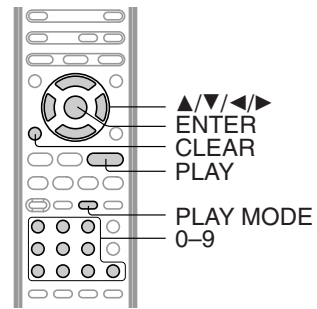

VCD Program playback

1 Press PLAY MODE during stop mode.

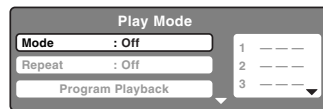

2 Press ▲/▼ to select "Mode", then press ENTER to select "Program".



3 Press ◀/▶ to select the programming position. Use Number buttons (0-9) to input the track numbers on sequentially.



- If you input a wrong number, press CLEAR.

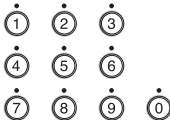

4 Press ◀/▶ to return to the left column, then press ▲/▼ to select the "Program Playback" and press ENTER.

The programs you selected will start to playback in the order.

- To resume normal playback, select Mode "Off" in step 2.

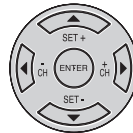

■ To change the program

- Select Mode to "Program" (as step 2), press ◀/▶/▲/▼ to select the track number you want to change, then press CLEAR.
- Press Number buttons (0-9) to overwrite the new track number.

■ To clear the program one by one

- Select Mode to "Program", press ◀/▶/▲/▼ to select the track number. Then press CLEAR.

■ To clear all the programs

- In the left column, press ▲/▼ to select "Clear Program". Then press ENTER.

Notes:

- In playing back the Video CD with PBC, you cannot set Program playback.
- The program is canceled when you open the disc tray or turn the power off.

VCD Random playback

1 Press PLAY MODE during playback or stop mode.



2 Press ▲/▼ to select "Mode", then press ENTER to select "Random".

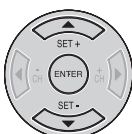

3 Press PLAY.



The Random Playback will start.

- If you set "Random" during playback mode, Random playback will begin after the track that is currently being played has ended.
- To resume normal playback, select Mode "Off" in step 2.

Note:

- In playing back the Video CD with PBC, you cannot set Random playback.



Changing angles/Title selection/DVD menu

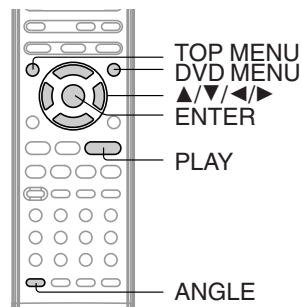

DVD Changing angles

When playing back a disc recorded with multi-angle facility, you can change the angle that you are viewing the scene from.

1 Press ANGLE during playback.
The current angle will appear.

COUNTER RESET ANGLE

2 Press ANGLE repeatedly until the desired angle is selected.

COUNTER RESET ANGLE

Note: Depending on the DVD, you may not be able to change the angles even if multi-angles are recorded on the DVD.

DVD Title selection

Two or more titles are recorded on some discs. If the title menu is recorded on the disc, you can select the desired title.

1 Press TOP MENU during playback.
Title menu appears on the screen.

TOP MENU

2 Press ▲/▼/◀/▶ to select the desired title.

3 Press ENTER or PLAY.
The playback of the selected title will start.

PLAY

Note: Depending on the DVD, you may not be able to select the title. Depending on the DVD, a "title menu" may simply be called a "menu" or "title" in the instructions supplied with the disc.

DVD DVD menu

Some DVDs allow you to select the disc contents using the menu. When you play back these DVDs, you can select the subtitle language and sound-track language, etc. using the menu.

1 Press DVD MENU during playback.
The DVD menu appears on the screen.

DVD MENU

- Press **DVD MENU** again to resume playback at the scene when you pressed **DVD MENU**.

2 Press ▲/▼/◀/▶ to select the desired item.

3 Press ENTER.
The menu continues to another screen. Repeat steps 2 and 3 to set the item completely.

Note: Depending on the DVD, you may not be able to resume playback from the scene point when you press **DVD MENU**.

Advanced playback (DVD)

Changing soundtrack language/ Setting surround sound

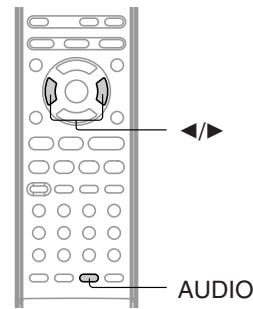

Changing soundtrack language

You can select the language when you play a multilingual disc.

1 Press **AUDIO** during playback.

AUDIO SELECT
AUDIO The current soundtrack language will appear.

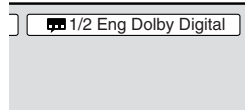

2 Press **AUDIO** repeatedly until the desired language is selected.

AUDIO SELECT
AUDIO

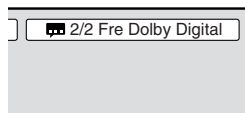

- The on screen display will disappear after a few seconds.

■ In case of Video CD playback

Audio type changes as follows each time you press **AUDIO**.



Notes:

- If the desired language is not heard after pressing the button several times, the language is not recorded on the disc.
- Changing soundtrack language is canceled when you open the disc tray. The initial default language or available language will be heard if the disc is played back again.

Setting surround sound

This DVD video player equipped with a "QSound". It can produce the effect of being in a cinema or a concert hall.

1 During disc playback press **AUDIO**.

AUDIO SELECT
AUDIO

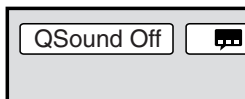

2 Press **◀** or **▶** to select "On".

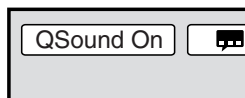

- The on screen display will disappear after a few seconds.

■ To cancel Surround mode:

Follow the left steps 1~2, then press **◀** or **▶** to select the "Off" position.

Notes:

- The "QSound" is effective only for the sound of disc.
- The QSound setting can also be changed in the function setting **62**.
- This function works only when the disc recorded with Dolby Digital is played back.
- When this function works, the volume might changed.
- When the voice is distorted, turn off QSound.



Manufactured under license from QSound Labs, Inc. U.S. patent Nos. 5,105,462, 5,208,860 and 5,440,638 and various foreign counterpart. Copyright QSound Labs, Inc. 1998-2002. QXpander™ is a trademark of QSound Labs, Inc. All rights reserved.



Subtitles/To turn off the PBC

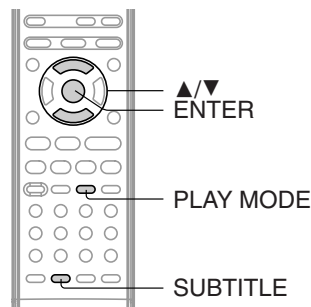

DVD Subtitles

When playing back a disc recorded with subtitles, you can select the subtitle language or turn the subtitle off.

1 Press **SUBTITLE** repeatedly during playback until your desired language appears.

2 To turn off the subtitle, press **SUBTITLE** until "Off" appears.

- The on screen display will disappear after a few seconds.

Notes:

- Depending on the DVD, you may not be able to change subtitles, or to turn subtitles on or off.
- While playing a DVD, the subtitle may change when you open or close the disc tray.
- In some cases, a selected subtitle language may not be changed immediately.

VCD To turn off the PBC

1 Press **PLAY MODE** in the stop mode.

2 Press **▲/▼** to select "Mode", then press **ENTER** repeatedly until "Off" appear.

3 Press **PLAY MODE** again to clear the screen.

■ To turn on the PBC

Follow the above steps 1~2, then press **ENTER** repeatedly until "PBC" appear.

Advanced playback (DVD)

MP3/WMA/JPEG/DivX[®] and Audio CD operation

This player can play back the MP3/WMA/JPEG/DivX[®]-data which has been recorded on CD-R or CD-RW. To produce the MP3/WMA/JPEG/DivX[®]-data, you need a Windows-PC with CD-RW drive and a MP3/WMA/JPEG/DivX[®]-encoding Software (not supplied). The Apple-HFS-System cannot be played.

Note:

This unit requires discs/recordings to meet certain technical standards in order to achieve optimal playback quality. Pre-recorded DVDs are automatically set to these standards. There are many different types of recordable disc formats (including CD-R containing MP3/WMA files). Given the fact that technology in this area is still maturing, Toshiba cannot guarantee that all genre of recordable discs will produce optimal playback quality. The technical criteria set out in this owner's manual are meant as a guide only.

Please be advised that you must obtain permission from the applicable copyright owners to download copyrighted content, including music files, in any format, including the MP3 and WMA formats, prior to the downloading thereof. Toshiba has no right to grant and does not grant permission to download any copyrighted content.

MP3/WMA/JPEG/DivX[®] CD information

Limitations on MP3/WMA/JPEG/DivX[®] CD playback

- MP3/WMA/JPEG/DivX[®] CD is the disc that is standardized by ISO9660, its file name must include 3-digits extension letters, ".mp3", ".wma", ".jpg", ".div", ".divx", ".avi".
- MP3/WMA/JPEG/DivX[®] CD must be correspond to the ISO standardized files.
- This unit can read 600 files per disc. If one directory has more than 600 files, the remaining files will be omitted.
- The unit is able to recognize up to a maximum of 50 directories per disc.
- MP3/WMA/JPEG/DivX[®] CDs cannot be used for the purpose of recording.
- If the CD has both audio tracks and MP3/WMA/JPEG/DivX[®] files, only audio tracks are played.
- It may take more than one minute for this unit to read MP3/WMA/JPEG/DivX[®] files depending on its structure.
- Music recorded by "Joliet Recording Specification" can be played back, the file name is displayed (within 15 letters) on the screen. Long file names will be condensed.
- The music files recorded by "Hierarchical File System" (HFS) cannot be played.

Limitations on display

- The maximum number for display is 15 letters.
Available letters for display are the following:
capital or small alphabets of A through Z, numbers of 0 through 9, and _ (under score).
- Other letters than those above are replaced in hyphen.

Notes on MP3/WMA/JPEG/DivX[®] files

To play back MP3/WMA/JPEG/DivX[®] CD in the recorded order,

1. Use MP3/WMA/JPEG/DivX[®] software that records data alphabetically or numerically.
2. Name each file including two-digit or three-digit number (ex. "01" "02" or "001" "002").
3. Refrain from making too many sub-folders.

CAUTION:

- Some MP3/WMA/JPEG/DivX[®] CDs cannot be played back depending on the recording conditions.
- The CD-R/RW that has no music data or non MP3/WMA/JPEG/DivX[®] files cannot be played back.

Standard, sampling frequency, and the bit rate:

MP3 CD

MPEG-1 Audio

32kHz, 44.1kHz, 48kHz

32kbps ~ 320kbps (constant bit rate or variable bit rate)

The recommend recording setting for a high-quality sound is 44.1kHz of sampling frequency and 128kbps of constant bit rate.

WMA CD

WMA version 7, and 8

32kHz/48kbps, 44.1kHz/48kbps~192kbps, 48kHz/128kbps~192kbps

The file recorded by mono, 48kHz, 48 kbps is not available to this unit.

DivX[®] video

DivX[®] version: DivX[®] 3, 4, 5, and 6 (specifically 3.1.1, 4.1.2, 5.0.2, 5.0.5, 5.1.1, 5.2.1, 6.0 at Home Theater profile).

Audio format: MPEG1 Layer2 (MP2), MPEG1 Layer3 (MP3)

Sampling frequencies: 32kHz, 44.1kHz, 48kHz

Bit rate: 32kbps ~ 320kbps



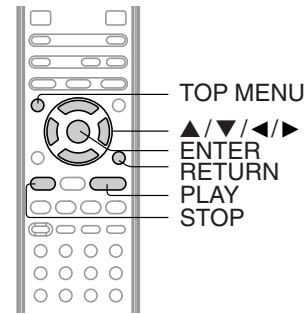

Resolution: Max 720 x 576 (at 25fps), Max 720 x 480 (at 30fps)

Microsoft, Windows Media, and Windows Logo are either registered trademarks or trademarks of Microsoft Corporation in the United States and/or other countries.

DivX, DivX Certified, and associated logos are trade marks of DivX, Inc. and are used under license.

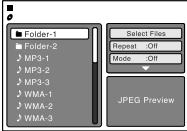

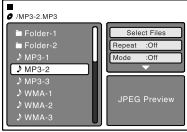
CD MP3/WMA CD and Audio CD playback

- 1** Place an Audio CD or a disc on which MP3 or WMA files have been recorded onto the disc tray.
- 2** A file browser screen will appear on the screen.
 
- 3** Press ▲/▼ to select file.
 

 - In case the current directory includes more than 8 files, press ▲ or ▼ to scroll in the file list.
 - To see contents in folder, select the folder and then press **ENTER**. To return to the upstairs directory, select "Go Up ..." then press **ENTER**.
 - When **PLAY** is pressed after display the file browser, or when the disc tray is closed using **PLAY**, playback begins automatically starting from the first file. In this case, if the first file is an MP3/WMA file, only MP3/WMA files are played back in order. If the first file is a JPEG file, the first JPEG file is played back. If the first file is a DivX® file, the first DivX® file is played back. If there is no file at a root directory, playback does not begin automatically.
- 4** Press **ENTER**.
The selected file starts playing back.
 
- 5** Press **STOP** to end playback.
 
 - The unit records the stopped point. "■" appears on the screen. Press **PLAY** to resume playback (from the scene point).
 - If you press **STOP** again or unload the disc, the unit will clear the stopped point.

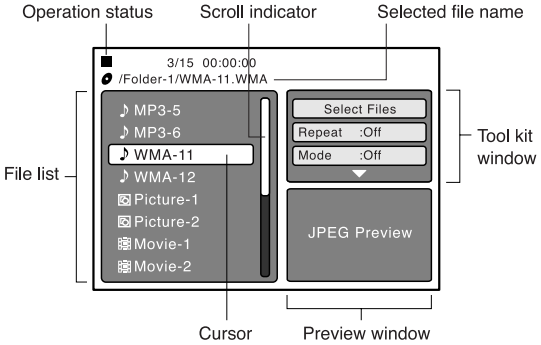
About file browser



Operation status Scroll indicator Selected file name

File list Cursor Preview window

Tool kit window

- ♪ : Indicates Music file (Audio/MP3/WMA)
- 🖼️ : Indicates Picture file (JPEG)
- 🎬 : Indicates Movie file (DivX® video)

Notes:

- The thumbnail list is displayed when the FUJICOLOR CD or the Kodak Picture CD are played. To display the file browser, press **TOP MENU**.
- In the case of a CD containing a mixture of MP3, WMA, JPEG and DivX® files, the files are played back by selecting them from the file browser.
- MP3 or WMA file on the Kodak Picture CD is not recognized on this unit.

- Notes:**
- During MP3/WMA/JPEG Playback, you cannot use JUMP and A-B Repeat functions.
 - You can use Repeat (Track or All), Random functions and Program playback for MP3/WMA/JPEG/DivX® CD Playback **[56]**, **[57]**.

- Select Files**
- The file type to make it display in the file browser can be chosen.
1. Press ◀ or ▶ to highlight "Select Files" at right column in the file browser.
 2. Press **ENTER**, then press ▲ or ▼ to select file type from the list (Music, Picture or Movie).
 3. Press **ENTER** to add/remove check mark. Checked file type will be displayed in the file browser.
 4. Press **RETURN** to save the setting.

Advanced playback (DVD)



MP3/WMA/JPEG/DivX® and Audio CD operation (Continued)

CD JPEG CD playback

1 Place a disc on which JPEG files have been recorded onto the tray.

2 A file browser screen will appear on the screen.

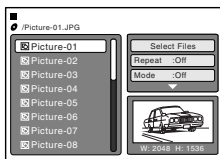

3 Press ▲/▼ to select the file. To display a thumbnail list, press DVD MENU. Press ◀/▶ or ▲/▼ to select the desired file. (To return to a file browser, press TOP MENU.)

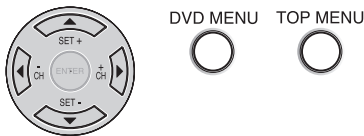

- When **PLAY** is pressed after displaying the file browser, or when the disc tray is closed after pressing **PLAY**, playback begins automatically starting from the first file. In this case, if the first file is a JPEG file, the first JPEG file is played back. If the first file is a DivX® file, the first DivX® file is played back. If the first file is an MP3/WMA file, only MP3/WMA files are played back in order. If there is no file at a root directory, playback does not begin automatically.

4 Press **ENTER** or **PLAY**. The selected picture appears on the screen.

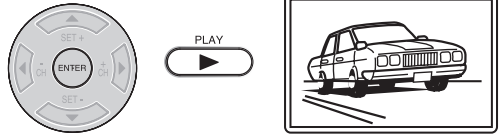

Rotating an image
You can rotate an image by 90 degrees by pressing **ANGLE** during playback of the image.

“↔”, “↕”, “↔↕” or “↕↔” appears on the screen.

5 Press **STOP** to end playback. The file browser appears on the screen. If you want to watch the other file, repeat steps 3 ~ 4.



CD Slide show playback

The slide show enables you to view pictures (files) one after another automatically.

Preparation:
Set “JPEG Interval” setting to “5 Seconds”, “10 Seconds” or “15 Seconds” [61].

1 Select your desired starting file for the slide show in the step 3 as left.

2 Press **ENTER** or **PLAY** to start slide show from the selected file.



- If you press **PAUSE/STEP** during the slide show, the slide show stops temporary. “||” appears briefly on the picture. If the picture appears upside down or sideways, press **ANGLE** repeatedly until it's right side up. “↔”, “↕”, “↔↕” or “↕↔” appears on the screen. Press **PLAY** or **SKIP** again to resume the slide show.
- When the slide show playback, finished the file list appears.
- To stop the slide show, press **STOP**. The file list appears.

Notes:

- Zoom function also can be used in viewing JPEG files. See “Zooming” [45].
- During JPEG playback, you cannot use Jump and A-B Repeat functions.

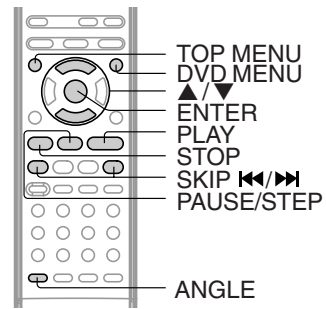

CD DivX® CD playback

1 Place a disc on which DivX® files have been recorded onto the tray.

2 A file browser screen will appear on the screen.

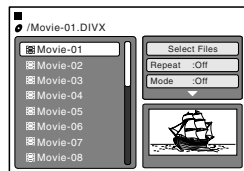

3 Press ▲/▼ to select file.

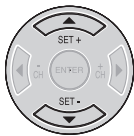

- When **PLAY** has been pressed after displaying the file browser, or when the disc tray has been closed after pressing **PLAY**, playback begins automatically starting from the first file. In this case, if the first file is a JPEG file, the first JPEG file is played back. If the first file is a DivX® file, the first DivX® file is played back. If the first file is an MP3/WMA file, only MP3/WMA file are played back in order. If there is no file at a root directory, playback does not begin automatically.

4 Press **ENTER** or **PLAY**. The selected DivX® movie will be played back on the screen.

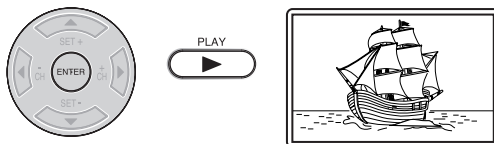

5 Press **STOP** to end playback. The file browser appears on the screen. If you want to watch the other file, repeat steps 3 ~ 4.



Note:
During DivX® playback, you cannot use A-B Repeat function.

CD Playing DivX® VOD content

DivX® VOD content is protected by DRM (Digital Rights Management) system. This restricts playback of content to specific registered devices.

If the incorrect DRM file is loaded, "Authorization Error This player is not authorized to play this video." will appear on the screen.

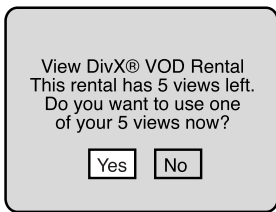

When you attempt to play DivX® VOD, the number of plays is limited and the right message will appear on the screen. If you wish to play it, select "YES".

- If the number of plays goes over the limit, then "Rental Expired" will be displayed, in this case the file will not be played.

Note:
In order to play DivX® VOD content on this unit, you first need to register the unit with registration code. See page **63**.

Advanced playback (DVD)

Repeat and program playback using file browser

CD Repeat playback (CD)

1 In the file browser, press ◀/▶ or ▲/▼ to select "Repeat" during stop mode.

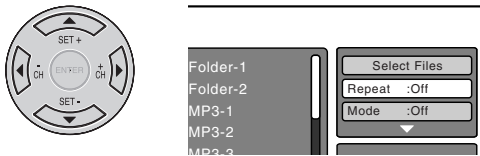

2 Press ENTER to select "Track" or "All".



3 Press PLAY.



The unit automatically starts repeat playback after finishing the current track.

■ **To resume normal playback**
Select Repeat : "Off" in step 2.

Notes:

- The program is canceled when you open the disc tray or turn the power off.
- In case of Audio CD, the function of A-B Repeat also can be used. See "A-B Repeat playback" [47](#).

CD Random playback (CD)

1 In the file browser, press ◀/▶ or ▲/▼ to select "Mode" during stop mode.

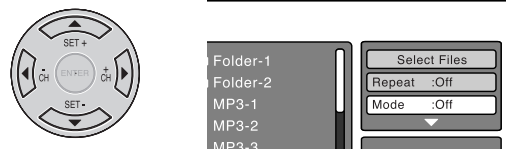

2 Press ENTER to select "Random".



3 Press PLAY.



The Random playback will start.

■ **To resume normal playback**
Select Mode : "Off" in step 2.

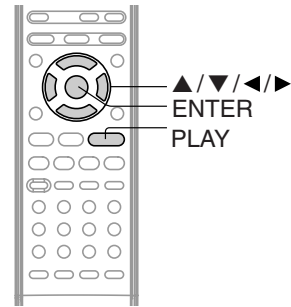

CD Program playback (CD)

1 In the file browser, press ◀/▶ or ▲/▼ to select “Edit Mode”, then press ENTER.



When “Edit Mode” is black color, you can mark the files which you want to add into Program list.

2 Press ◀/▶ or ▲/▼ to select file you want to add into the program list.

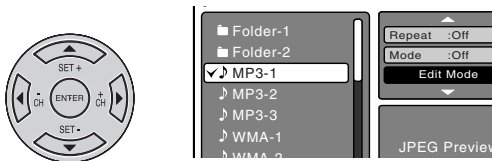

Press ENTER. Selected file was marked. Repeat this procedure to select the other files.

3 Press ◀/▶ or ▲/▼ to select “Add To Program”. Then press ENTER. All marked files are added into the program list.

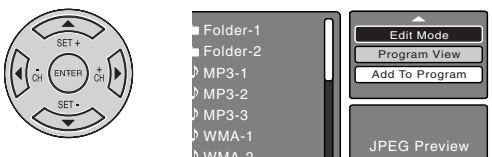

•When you finish store all files which you want into the Program list, press “Edit Mode” again to release edit mode.

4 Press ◀/▶ or ▲/▼ to select “Program View”, then press ENTER. Program View shows only the programmed files that you have added step 2.

Program View

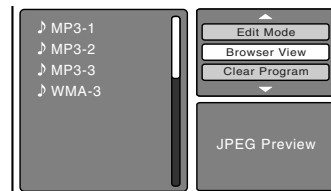

Browser View

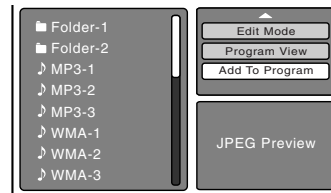

5 In the Program View, press PLAY. The files start to playback in programmed order that were added by you.

To remove file from program list

In the Edit Mode, switch to Program View. Select file you want to remove, then press ENTER. Select “Clear Program” and press ENTER. Marked file is removed from program list.

Customizing the function settings

You can change the default settings to customize performance to your preference.

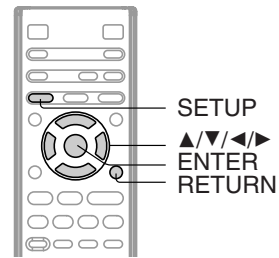

DVD VCD CD Setting procedure

1 Press SETUP during stop mode.

VCR MENU
SETUP

The following on-screen display appears.

| | | |
|--|----------|-----------|
| | Menu | : English |
| | Subtitle | : English |
| | Audio | : English |

2 Press ▲ or ▼ to select the desired section, then press ◀ or ▶.

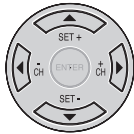

| | | |
|--|---------------|--------------------------------|
| | E.B.L. | : Off |
| | TV Screen | : 4:3 <input type="checkbox"/> |
| | Display | : On |
| | Picture Mode | : Auto |
| | JPEG Interval | : Off |
| | Screen Saver | : On |

3 First option will be highlighted. Press ▲ or ▼ to select the desired option.



| | | |
|--|---------------|--------------------------------|
| | E.B.L. | : Off |
| | TV Screen | : 4:3 <input type="checkbox"/> |
| | Display | : On |
| | Picture Mode | : Auto |
| | JPEG Interval | : Off |
| | Screen Saver | : On |

4 Then press ▶ or ENTER. The selectable settings will appear.



| | | |
|--|---------------|--------|
| | E.B.L. | ▼ Off |
| | TV Screen | On |
| | Display | : On |
| | Picture Mode | : Auto |
| | JPEG Interval | : Off |
| | Screen Saver | : On |

5 Change the selection using ▲ or ▼, by referring to the corresponding pages 60 ~ 63. Press ENTER to save the setting.



- Repeat steps 3 and 5 to change other option.
- To select another section, go back to step 2 by pressing ◀ repeatedly.

6 To clear SETUP screen, press SETUP or RETURN.

VCR MENU
SETUP





RETURN



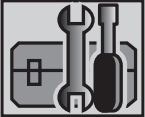

Setting details

| Section | Option | Details | Page |
|---|----------------------------|---|-----------|
|  | Menu Subtitle Audio | To select the language of "Menu", "Subtitle" and "Audio" if more than one language are available on the disc. | 60 |
| | E.B.L. | To select On or Off for E.B.L. (Enhanced Black Level). | 60 |
|  | TV Screen | To select a picture size according to the aspect ratio of your TV. | 61 |
| | Display | To turn on or de-activate the operational status display on the screen. | |
| | Picture Mode | To select a preferred picture mode from "Video", "Film" or "Auto". | |
| | JPEG Interval | To select a preferred setting for the slide show playback. | |
| | Screen Saver | To select On or Off for Screen Saver function. | |
|  | DRC | To select On or Off for DRC (Dynamic Range Control). | 62 |
| | QSound | To select On or Off for QSound. | |
|  | Parental | To select a preferred parental level for the parental setting. | 62 |
| | Password | Input 4-digit password to set the parental level. | |
| | Output | To select a preferred video output signal from "Interlace" or "Progressive". | 63 |
| | DivX(R) VOD | To display your 8 character registration code. | |

Function setup (DVD)

Customizing the function settings (Continued)

Setting details



| | | |
|--|----------|-----------|
| | Menu | : English |
| | Subtitle | : English |
| | Audio | : English |

■ Menu, Subtitle, Audio

You can select the language of “Menu”, “Subtitle” and “Audio” if more than one languages are recorded onto the disc.

English, Francais, Espanol:

The selected language will be heard or seen.

Other:

Other language can be selected (see the “Language code list” [65](#)).

Original: (Audio)

The unit will select the first priority language of each disc.

Off: (Subtitle)

Subtitles do not appear.

Notes:

- If the selected language is not recorded on the disc, the first-priority language is selected.
- If you want to change the OSD language, you can perform it by VCR MENU [23](#).



| | | |
|--|---------------|--------------------------------|
| | E.B.L. | : Off |
| | TV Screen | : 4:3 <input type="checkbox"/> |
| | Display | : On |
| | Picture Mode | : Auto |
| | JPEG Interval | : Off |
| | Screen Saver | : On |

■ E.B.L.

To select the black level of playback pictures, set your preference and monitor’s ability.

Off: Standard grey scale (7.5 IRE cut off)

On: Enhanced grey scale (0 IRE cut off)

■ TV Screen

You have the following screen sizes to choose from:

4:3 (Letter box):

Select this mode when connecting to a conventional TV. When playing back a wide screen-DVD disc, it displays the wide picture with black bands at the top and bottom of screen.

4:3 (Pan scan):

It displays the wide picture on the whole screen with left and right edges automatically cut off.

16:9 (Wide):

Select this mode when connecting to a wide-screen TV. A wide screen picture is displayed full size.

Note:

If the DVD disc is not formatted in the pan & scan style, it displays 4:3 style.



■ Display

On screen display can be switched on or off when you press the buttons.

- Off:** On screen displays do not appear when you press any buttons.
- On:** On screen displays appear when you press the buttons (factory setting).

■ Picture Mode

There are two types of source content in pictures recorded in DVD video discs: film content (pictures recorded from films at 24 frames per second) and video content (video signals recorded at 30 frames per second). Make this selection according to the type of content being viewed.

- Auto:** Select this position normally. The DVD player automatically detects source content, film or video, of playback source, and converts that signal in the progressive output format in an appropriate method.
- Film:** The DVD player converts film content pictures in the progressive output format appropriately. Suitable for playback of film content pictures. The progressive output feature will be most effective under this selection.
- Video:** The DVD player filters video signal, and converts it in the progressive output format appropriately. Suitable for playback of video content pictures.

Note:
Depending on the disc, pictures may be cut off or doubled. In this case, select "Video".

■ JPEG Interval

You can continuously play back all JPEG files automatically.
After the setting below, start playing the disc on which JPEG files have been recorded.

- Off:**
Plays back one file at a time.
- 5 Seconds:**
Plays back images in the form of a slide show at 5 second intervals.
- 10 Seconds:**
Plays back images in the form of a slide show at 10 second intervals.
- 15 Seconds:**
Plays back images in the form of a slide show at 15 second intervals.

■ Screen Saver

The screen saver operates when you leave the unit in DVD stop mode for approx. five minutes. The screen will repeatedly get dark gradually and back to normal.

- Off:**
Screen Saver function is invalidated.
- On:**
Screen Saver function is made effective.

Function setup (DVD)

Customizing the function settings (Continued)

Setting details



DRC : Off
QSound : Off

■ DRC

DRC (Dynamic Range Control) enables you to control the dynamic range so as to achieve a suitable sound for your equipment.

Off:

It plays back at the recording level on the disc.

On:

Loud sound such as explosion or similar is toned down slightly when played back. This makes it suitable for when it is connected to a stereo.

Notes:

- This function works only during playback of Dolby Digital recorded discs.
- The level of Dynamic Range Reduction may differ depending on DVD video disc.

■ QSound

This DVD video player equipped with a "QSound". It can produce the effect of being in a cinema or a concert hall.

Off: The QSound is disengaged.

On: The QSound operates.

Notes:

- The QSound setting can also be changed with **AUDIO** on the remote control **[50]**.
- This function works only when the disc recorded with Dolby Digital is played back.
- When this function works, the volume might changed.
- When the voice is distorted, turn off QSound.

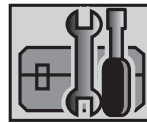

Parental : Off
Password : Change
Output : Interlace
DivX(R) VOD : Display

■ Parental control setting

Some discs are specified not suitable for children. Such discs can be limited not to play back with the unit.

- 1) Press **▲** or **▼** to select "Parental", then press **ENTER**. "Enter Password" will appear.
- 2) Press "0000" using **Number buttons (0-9)**. (Please note, this is pre-setting password of this unit). Then press **ENTER**. The parental level list will appear.
 - **Level Off:** The parental control setting does not function.
 - **Level 8:** All DVD software can be played back.
 - **Level 1:** DVD software for adults cannot be played back.
- 3) Press **▲** or **▼** to select from the level 1 to level 8. The limitation will be more severe as the level number is lower.
- 4) Press **OPEN/CLOSE** to activate Parental control setting.

Notes:

- Depending on the discs, the unit cannot limit playback.
- Some discs may not be encoded with specific rating level information though its disc jacket says "adult." For those discs, the age restriction will not work.
- The password is required every time when you change the parental level.
- If you input a wrong number, press **CLEAR**.

■ Set the new password

- 1) Press **▲** or **▼** to select "Password", then press **ENTER**. "Enter Current Password" will appear.
- 2) Press **Number buttons (0-9)** to input the current password (If the password has not been set yet after you purchase this unit, it is "0000").
- 3) Then press **ENTER**. "Enter New Password" will appear. Press **Number buttons (0-9)** to input the new password.
- 4) Press **ENTER**. Now your new password has been set. Be sure to remember this number!



If you forget the password...

- 1) Press **OPEN/CLOSE** to open the disc tray.
- 2) Remove the disc.
- 3) Press **OPEN/CLOSE** again to close the disc tray. "No Disc" appears on the screen.
- 4) While holding **7** down on the remote control and then press **STOP** on the front panel. "Password Clear" appears on the screen. Now the password has been returned to the initial value ("0000").

■ Output

You can select the video output signal of the DVD video player to the TV from "Interlace" or "Progressive".

Interlace:

Select when connecting to a composite TV or a TV equipped with component video inputs but progressive scan is not compatible.

Progressive:

Select when connecting to a TV equipped with component video inputs, progressive scan compatible.

Warning:

Once "Progressive" is selected when connecting to a TV progressive scan incompatible, no image will be seen on the video display.

In this case, you must reset the unit by pressing **STOP** on the front panel for five seconds. The video output will be restored to "Interlace" setting, and a picture will once again be seen on a conventional analog display.

Notes:

- Some discs may not be played back with the progressive scanning mode correctly because of the disc characteristics or recording condition.
- Once Progressive scan on, S-video output is disabled.

■ DivX® VOD

In order to play DivX® VOD (Video On Demand) content on this unit, you first need to register the unit with your DivX® VOD content provider. You do this by generating a DivX® VOD registration code, which you submit to your provider.

Press **▲** or **▼** to select "DivX(R) VOD". Then press **ENTER**. Your 8-character registration code is displayed. Make a note of the code as you will need it when you register with a DivX® VOD provider. Then press **ENTER**.

Note:

If each setup (pages 60 ~ 63) has been completed, the unit can always be worked under the same conditions (especially with DVD discs). Each setup will be retained in the memory even if you turn the power off.

Function setup (DVD)

Temporary disabling of rating level by DVD disc

Depending on the DVD disc, the disc may try to temporarily cancel the rating level that you have set. It is up to you to decide whether to cancel the rating level or not.

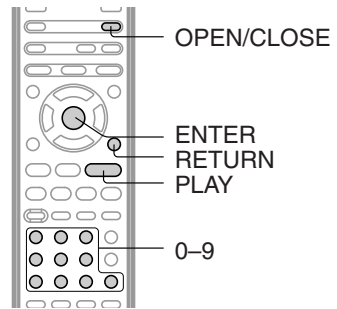

- 1** Load a DVD disc and press **PLAY** or **OPEN/CLOSE** on the unit [42].

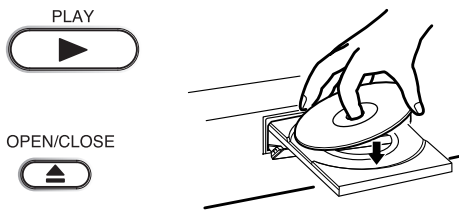

- 2** If the DVD disc has been designed to temporarily cancel the Rating level, the screen which follows the "Reading" screen will change, depending on which disc is played. If you select "YES" with the **ENTER** key, password input screen will then appear.

- 3** Enter the password with **Number** buttons (0-9). Then press **ENTER**.

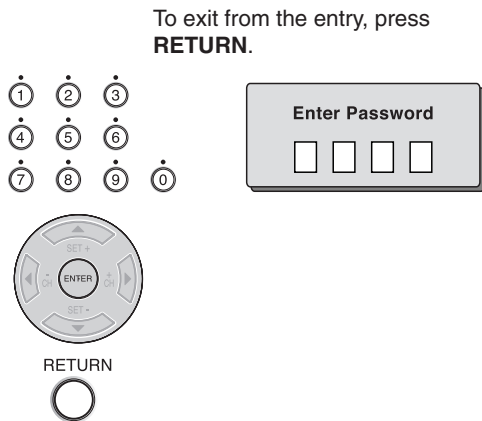

- 4** Playback will commence if the entered password was correct.

Note:

This temporary cancellation of rating level will be kept until the disc is ejected. When the disc is ejected, the original rating level will be set again automatically.

Language code list

Enter the appropriate code number for the initial settings "Menu", "Subtitle" and/or "Audio" (60).

| Language Name Code | Language Name Code | Language Name Code | Language Name Code |
|----------------------|-----------------------|---------------------|--------------------|
| Abkhazian 1112 | Fiji 1620 | Lingala 2224 | Singhalese 2919 |
| Afar 1111 | Finnish 1619 | Lithuanian 2230 | Slovak 2921 |
| Afrikaans 1116 | French 1628 | Macedonian 2321 | Slovenian 2922 |
| Albanian 2927 | Frisian 1635 | Malagasy 2317 | Somali 2925 |
| Amharic 1123 | Galician 1722 | Malay 2329 | Spanish 1529 |
| Arabic 1128 | Georgian 2111 | Malayalam 2322 | Sundanese 2931 |
| Armenian 1835 | German 1415 | Maltese 2330 | Swahili 2933 |
| Assamese 1129 | Greek 1522 | Maori 2319 | Swedish 2932 |
| Aymara 1135 | Greenlandic 2122 | Marathi 2328 | Tagalog 3022 |
| Azerbaijani 1136 | Guarani 1724 | Moldavian 2325 | Tajik 3017 |
| Bashkir 1211 | Gujarati 1731 | Mongolian 2324 | Tamil 3011 |
| Basque 1531 | Hausa 1811 | Nauru 2411 | Tatar 3030 |
| Bengali; Bangla 1224 | Hebrew 1933 | Nepali 2415 | Telugu 3015 |
| Bhutani 1436 | Hindi 1819 | Norwegian 2425 | Thai 3018 |
| Bihari 1218 | Hungarian 1831 | Oriya 2528 | Tibetan 1225 |
| Breton 1228 | Icelandic 1929 | Panjabi 2611 | Tigrinya 3019 |
| Bulgarian 1217 | Indonesian 1924 | Pashto, Pushto 2629 | Tonga 3025 |
| Burmese 2335 | Interlingua 1911 | Persian 1611 | Turkish 3028 |
| Byelorussian 1215 | Irish 1711 | Polish 2622 | Turkmen 3021 |
| Cambodian 2123 | Italian 1930 | Portuguese 2630 | Twi 3033 |
| Catalan 1311 | Japanese 2011 | Quechua 2731 | Ukrainian 3121 |
| Chinese 3618 | Javanese 2033 | Rhaeto-Romance 2823 | Urdu 3128 |
| Corsican 1325 | Kannada 2124 | Romanian 2825 | Uzbek 3136 |
| Croatian 1828 | Kashmiri 2129 | Russian 2831 | Vietnamese 3219 |
| Czech 1329 | Kazakh 2121 | Samoan 2923 | Volapük 3225 |
| Danish 1411 | Kirghiz 2135 | Sanskrit 2911 | Welsh 1335 |
| Dutch 2422 | Korean 2125 | Scots Gaelic 1714 | Wolof 3325 |
| English 1524 | Kurdish 2131 | Serbian 2928 | Xhosa 3418 |
| Esperanto 1525 | Laothian 2225 | Serbo-Croatian 2918 | Yiddish 2019 |
| Estonian 1530 | Latin 2211 | Shona 2924 | Yoruba 3525 |
| Faroese 1625 | Latvian, Lettish 2232 | Sindhi 2914 | Zulu 3631 |

Troubleshooting

Before calling a service technician, please check the following table for a possible cause of the symptoms and some solutions.

| Symptoms | Solutions | Page |
|---|--|--------------------------------|
| DVD/VCR | | |
| DVD/VCR does not operate. | <ul style="list-style-type: none"> • Make sure the power cord is plugged in. • Try another AC outlet. • Unplug unit, then plug it back in. • Select the DVD or VCR mode before operating. | 5 – 5 30,42 |
| No picture. | <ul style="list-style-type: none"> • Antenna connection is not correct or antenna cable is disconnected. • The video channel is not in the correct position or the TV is not set to the video channel 3 or 4. • Check the unit is connected correctly. • The video input selector of the TV is not set to VIDEO. Set to VIDEO (or equivalent). • Channel is set to the external mode. | 14-17 22 14-19 – – |
| No sound. | <ul style="list-style-type: none"> • Check the unit is connected correctly. • Check the input selector of the amplifier is set properly. • The unit is in the Special playback mode. | 14-19 – 31,44 |
| The remote control does not function. | <ul style="list-style-type: none"> • Aim the remote control at the remote sensor. • Operate within Approx. 7 Meters or reduce the light in the room. • Clear the path of the beam. • The batteries are weak. Replace the batteries. • Check the batteries are inserted correctly. | 13 |
| No Cable TV reception. | <ul style="list-style-type: none"> • Check all Cable TV connections. • Station or Cable TV system problems, try another station. | 16,17 |
| VCR | | |
| TV recording does not work. | <ul style="list-style-type: none"> • The erase prevention tab of the video cassette is broken off. • The unit is in the external input mode. | 29,34 |
| Timer recording does not work. | <ul style="list-style-type: none"> • The time is not set correctly. • The recording start/end time is not set correctly. • The TIMER REC has not been pressed (⏻ is not lit). | 24-26 37 37 |
| Noise bars on screen. | <ul style="list-style-type: none"> • Tracking adjustment beyond range of automatic tracking circuit. Try Manual tracking adjustment. • Video heads are dirty. • The tape is worn or damaged. | 31 31 – |
| DVD | | |
| Display is not shown in your language. | <ul style="list-style-type: none"> • Select proper language in the menu options. | 60 |
| Playback doesn't start. | <ul style="list-style-type: none"> • No disc is inserted. • The disc may be dirty. Clean up the disc. • The unit cannot play DVD-ROMs, etc. | 42 7 8 |
| Stopping playback, slow-motion play, repeat play, or memory play, etc. cannot be performed. | <ul style="list-style-type: none"> • Some discs may not do some of the functions. | – |
| No picture, or the screen is blurred or divided into two parts. | <ul style="list-style-type: none"> • The PROGRESSIVE scan is "On" although the unit is connected to a TV via the VIDEO OUT or the S-VIDEO OUT jack. | 63 |
| No 4:3 (16:9) picture. | <ul style="list-style-type: none"> • The setup does not match your TV. | 60 |
| No on-screen display. | <ul style="list-style-type: none"> • Select Display to "On". | 61 |
| No surround sound. | <ul style="list-style-type: none"> • The setup does not match your stereo system. | 20 |
| The unit or remote operation key is not functioning. | <ul style="list-style-type: none"> • Turn off the unit and unplug the AC power cord for several minutes, then replug it. | – |
| Playback does not start when the title is selected. | <ul style="list-style-type: none"> • Check the Parental setup. | 62,64 |
| Audio soundtrack and/or subtitle language is not changed when you play back a DVD. | <ul style="list-style-type: none"> • Multilingual language is not recorded on the DVD disc. | 50,51 |
| No subtitle. | <ul style="list-style-type: none"> • Some discs have no subtitles. • Subtitles are cleared. Press SUBTITLE. | 51 |
| Angle cannot be changed. | <ul style="list-style-type: none"> • Multi-angles are not recorded on the DVD disc. | 49 |
| "X" appears on the screen. | <ul style="list-style-type: none"> • The function is prohibited with the unit or the disc. | 44 |



Specifications

General

| | |
|----------------------------|--|
| Power supply | AC 120 V 60 Hz |
| Power consumption | Operation: 18 W, Stand by: 2 W |
| Weight | 7.7 lbs (3.5 kg) |
| Dimensions | Width: 16-15/16 inches (430.6 mm) Height: 3-9/16 inches (89.7 mm) Depth: 9 inches (228.7 mm) |
| Tuner | 181 channel freq. synthesized VHF 2-13 UHF 14-69 Cable TV 113 Channels |
| Antenna input/output | UHF/VHF In/Out: 75 Ω coaxial |
| RF channel output | Channel 3 or 4, Switchable |
| Color system | NTSC |
| Video head | 4 Rotary heads |
| Audio track | Hi-Fi sound - 2 Tracks / MONO sound - 1 Track |
| Hi-Fi frequency response | 20 Hz to 20,000 Hz |
| Hi-Fi dynamic range | More than 90dB |
| FF/REW time at 25°C (77°F) | Approx. 1 minute and 48 seconds (with T-120 Cassette Tape) |
| Applicable disc | DVD (12 cm, 8 cm), CD (12 cm, 8 cm) |
| Frequency range | DVD: 4 Hz-22 kHz, CD: 4 Hz-20 kHz |
| S/N ratio | 85dB (DVD) |
| Harmonic distortion | 0.06% (DVD) |
| Wow and flutter | Less than 0.01% Wrms |
| Operating conditions | Temperature: 5°C-40°C (41°F-104°F), Operating status: Horizontal |

Input/Output

| | |
|--------------------------------|--|
| DVD/VCR | |
| Video input | 1.0 V (p-p), 75 Ω, negative sync., pin jack x 2 |
| Video output | 1.0 V (p-p), 75 Ω, negative sync., pin jack x 1 |
| Audio input | -8 dBm, 50 kΩ, negative sync., pin jack (L/R) x 2 |
| Audio output | -8 dBm, 1 kΩ, negative sync., pin jack (L/R) x 1 |
| DVD | |
| S-video output | (Y) 1.0 V (p-p), 75 Ω, negative sync., Mini DIN 4-pin x 1 (C) 0.286 V (p-p), 75 Ω |
| Component video output | (Y) 1.0 V (p-p), 75 Ω, negative sync., pin jack x 1 (P _B)/(P _R) 0.7 V (p-p), 75 Ω, pin jack x 2 |
| Audio output (COAXIAL DIGITAL) | 0.5 V (p-p), 75 Ω, pin jack x 1 |
| Audio output (ANALOG) | -12 dBm, 1 kΩ, pin jacks (L, R) x 1 |

Supplied accessories

| | |
|---------------------------------|---|
| Audio/video cable | 1 |
| Remote control (SE-R0220) | 1 |
| Batteries (R03/AAA) | 2 |
| 75 Ω coaxial cable | 1 |

- This model complies with the above specifications.
- Designs and specifications are subject to change without notice.
- This model may not be compatible with features and/or specifications that may be added in the future.

Others

Limited warranty

Limited United States Warranty DVD/VCR Combinations - Exchange Warranty

Toshiba America Consumer Products, L.L.C. ("TACP") makes the following limited warranties to original consumers in the United States. **THESE LIMITED WARRANTIES EXTEND TO THE ORIGINAL CONSUMER PURCHASER OR ANY PERSON RECEIVING THIS DVD/VCR COMBINATION AS A GIFT FROM THE ORIGINAL CONSUMER PURCHASER AND TO NO OTHER PURCHASER OR TRANSFEREE.**

PRODUCTS PURCHASED IN THE U.S.A. AND USED ANYWHERE OUTSIDE OF THE U.S.A., INCLUDING, WITHOUT LIMITATION, CANADA AND MEXICO, ARE NOT COVERED BY THESE WARRANTIES.

PRODUCTS PURCHASED ANYWHERE OUTSIDE OF THE U.S.A., INCLUDING, WITHOUT LIMITATION, CANADA AND MEXICO, AND USED IN THE U.S.A., ARE NOT COVERED BY THESE WARRANTIES.

Limited Ninety (90) Day Warranty

TACP warrants this DVD/VCR Combination and its parts against defects in materials or workmanship for period of ninety (90) days after the date of original retail purchase. **DURING THE FIRST NINETY (90) DAYS AFTER THE DATE OF ORIGINAL RETAIL PURCHASE, TACP WILL EXCHANGE A DEFECTIVE DVD/VCR COMBINATION WITH A NEW OR REFURBISHED DVD/VCR COMBINATION WITHOUT CHARGE TO YOU. YOU MUST CONTACT TACP'S CONSUMER SOLUTIONS CENTER FOR INSTRUCTIONS ON HOW TO PROCESS YOUR WARRANTY EXCHANGE REQUEST. THE CONSUMER IS RESPONSIBLE FOR ALL INBOUND TRANSPORTATION AND INSURANCE CHARGES FOR THE DVD/VCR COMBINATION TO THE EXCHANGE CENTER. DURING THE PERIOD THAT COMMENCES ON THE DATE THAT IS NINETY ONE (91) DAYS AFTER THE DATE OF ORIGINAL RETAIL PURCHASE AND BEYOND, TACP WILL EXCHANGE A DEFECTIVE DVD/VCR COMBINATION WITH A NEW OR REFURBISHED DVD/VCR COMBINATION FOR A NOMINAL FEE. YOU MUST CONTACT TACP'S CONSUMER SOLUTIONS CENTER FOR INSTRUCTIONS ON HOW TO PROCESS YOUR EXCHANGE REQUEST. THE CONSUMER IS RESPONSIBLE FOR ALL INBOUND TRANSPORTATION AND INSURANCE CHARGES FOR THE DVD/VCR COMBINATION TO THE EXCHANGE CENTER.**

* Rental Units

The warranty for rental units begins with the first rental or thirty (30) days after the date of shipment to the rental firm, whichever comes first.

* Commercial Units

DVD/VDR Combinations sold and used for commercial purposes have a limited ninety (90) day warranty for all parts and labor.

Owner's Manual and Product Registration Card

Read this owner's manual thoroughly before operating this DVD/VCR Combination. Complete and mail the enclosed product registration card or register your product on-line at www.tacp.toshiba.com/service as soon as possible. By registering your DVD/VCR Combination you will enable TACP to bring you new products specifically designed to meet your needs and help us to contact you in the unlikely event that a safety notification is required under the Consumer Product Safety Act. Failure to complete and return the product registration card does not diminish your warranty rights.

Your Responsibility

THE ABOVE WARRANTIES ARE SUBJECT TO THE FOLLOWING CONDITIONS:

- (1) You must retain your bill of sale or provide other proof of purchase.
- (2) All warranty servicing of this product must be made by an Authorized TACP Service Station.
- (3) The warranties from TACP are effective only if the product is purchased and operated in the Continental U.S.A. or Puerto Rico.
- (4) Labor service charges for set installation, setup, adjustment of customer controls and installation or repair of antenna systems are not covered by this warranty. Reception problems caused by inadequate antenna systems are your responsibility.
- (5) Warranties extend only to defects in materials or workmanship as limited above, and do not extend to any DVD/VCR Combination or parts that have been lost or discarded by you or to damage to the DVD/VCR Combination or parts caused by fires, misuse, accident, Acts of God (such as lightning or fluctuations in electric power), improper installation, improper maintenance, or use in violation of instructions furnished by TACP; use or malfunction through simultaneous use of this product and connected equipment; or to units that have been modified or had the serial number removed, altered, defaced, or rendered illegible.



How to Obtain Warranty Services

If, after following all of the operating instructions in this manual and checking the section "Troubleshooting," you find that service is needed:

- (1) For instructions on how to obtain warranty service for exchange program DVD/VCR Combinations, contact TACP's Call Center toll free at 1-866-583-7353.
- (2) You must include the original bill of sale (or a copy of the original bill of sale) or other proof of purchase along with the entire DVD/VCR Combination when sending the DVD/VCR Combination to the Authorized TACP Service Station specified by TACP's Call Center. You must pay for all transportation and insurance charges for the DVD/VCR Combination to and from the Authorized TACP Service Station.

For additional information, visit TACP's website:
www.tacp.toshiba.com

THIS WARRANTY GIVES YOU SPECIFIC LEGAL RIGHTS AND YOU MAY ALSO HAVE OTHER RIGHTS WHICH MAY VARY FROM STATE TO STATE IN THE U.S.A. SOME STATES OF THE U.S.A. DO NOT ALLOW LIMITATIONS ON HOW LONG AN IMPLIED WARRANTY LASTS, WHEN AN ACTION MAY BE BROUGHT, OR THE EXCLUSION OR LIMITATION OF INCIDENTAL OR CONSEQUENTIAL DAMAGES, SO THE ABOVE PROVISIONS MAY NOT APPLY TO YOU UNDER SUCH CIRCUMSTANCES.

ALL WARRANTIES IMPLIED BY THE LAW OF ANY STATE OF THE U.S.A., INCLUDING THE IMPLIED WARRANTIES OF MERCHANTABILITY AND FITNESS FOR A PARTICULAR PURPOSE, ARE EXPRESSLY LIMITED TO THE DURATION OF THE LIMITED WARRANTIES SET FORTH ABOVE. WITH THE EXCEPTION OF ANY WARRANTIES IMPLIED BY THE LAW OF ANY STATE OF THE U.S.A. AS HEREBY LIMITED, THE FOREGOING WARRANTY IS EXCLUSIVE AND IN LIEU OF ALL OTHER WARRANTIES, GUARANTEES, AGREEMENTS, AND SIMILAR OBLIGATIONS OF TACP WITH RESPECT TO THE REPAIR OR REPLACEMENT OF ANY PARTS. IN NO EVENT SHALL TACP BE LIABLE FOR CONSEQUENTIAL OR INCIDENTAL DAMAGES (INCLUDING, BUT NOT LIMITED TO, LOST PROFITS, BUSINESS INTERRUPTION, OR MODIFICATION OR ERASURE OF RECORDED DATA CAUSED BY USE, MISUSE OR INABILITY TO USE THIS PRODUCT).

No person, agent, distributor, dealer or company is authorized to change, modify or extend the terms of these warranties in any manner whatsoever. The time within which an action must be commenced to enforce any obligation of TACP arising under the warranty or under any statute, or law of the United States or any state thereof, is hereby limited to ninety (90) days from the date you discover or should have discovered, the defect. This limitation does not apply to implied warranties arising under state law.

Others



Others

Memo

Horizontal dotted lines for writing a memo





TOSHIBA

ColorStream and ColorStream Pro are registered trademarks of Toshiba America Consumer Products, L.L.C.



J2I30101B SH 06/02

Printed in Thailand